

Envel PANEL SYSTEM PROMOTIONAL DETAILS

MANUFACTURER'S SPECIFICATION AND DETAILS SUBJECT TO CHANGE WITHOUT NOTICE



TITLE:

Envel PANEL SYSTEM S175

DRAWN BY:
SS

DATE:
4/11/16

REV.

SCALE:
FULL

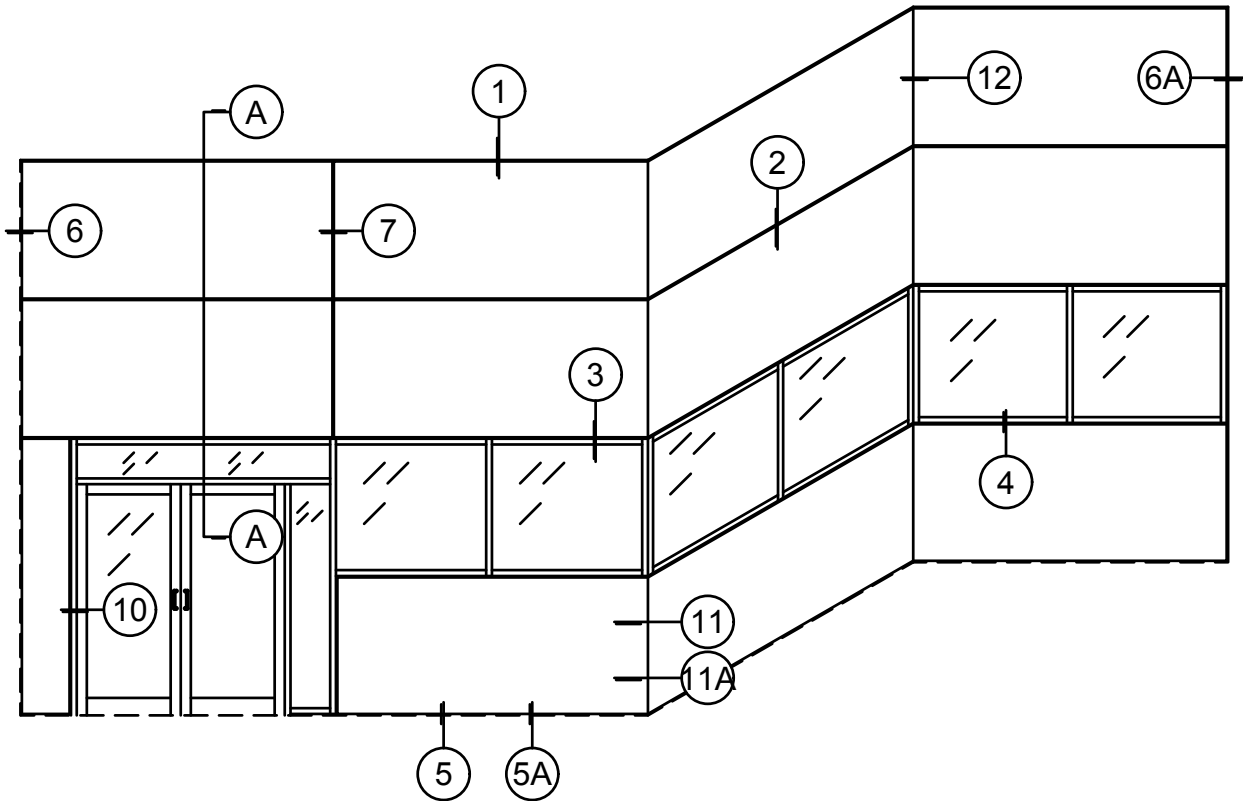

ELEVATION

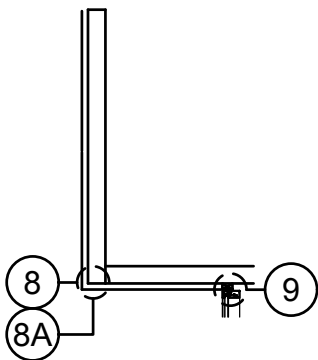

SECTION A-A



TITLE:

Envel PANEL SYSTEM S175

DRAWN BY:
SS

DATE:
4/11/16

REV.

SCALE:
3/16" = 1'-0"

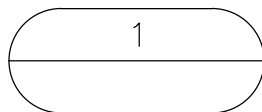
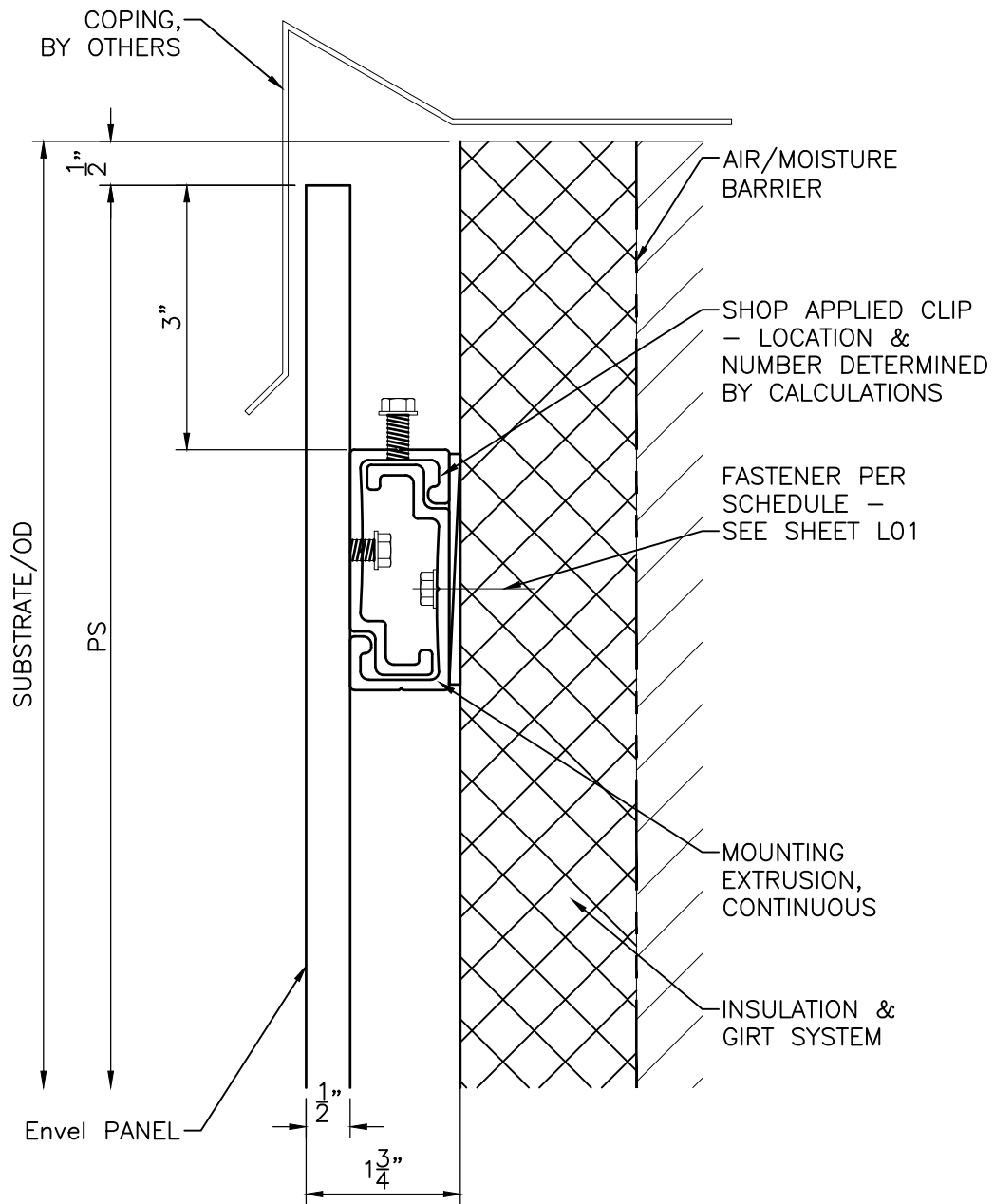

TYPICAL UPPER TERMINATION



TITLE:

Envel PANEL SYSTEM S175

DRAWN BY:
SS

DATE:
4/11/16

REV.

SCALE:
1:2

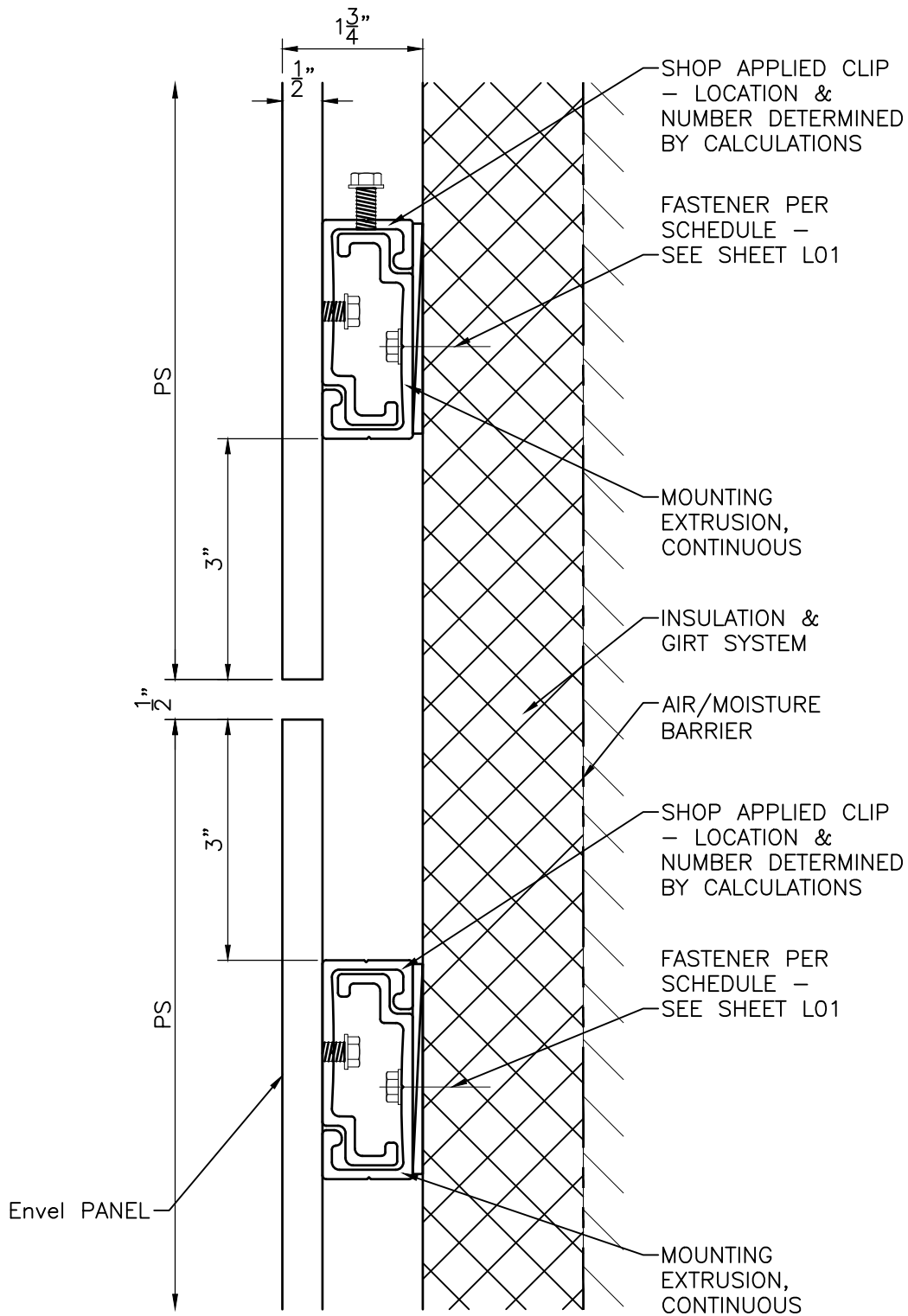

TYPICAL HORIZONTAL JOINT



TITLE:

Envel PANEL SYSTEM S175

DRAWN BY:
SS

DATE:
4/11/16

REV.

SCALE:
1:2

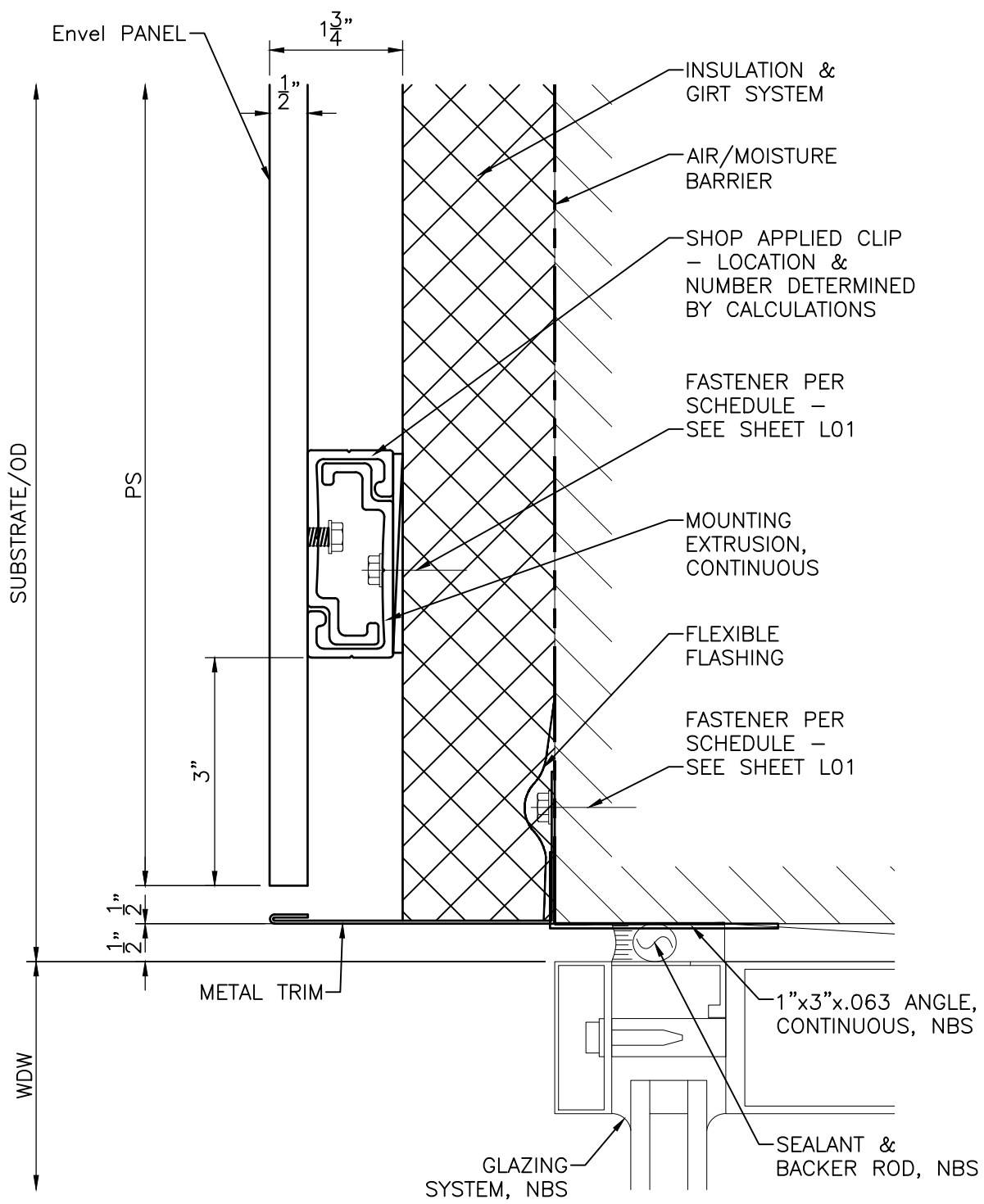

TYPICAL GLAZING HEAD



TITLE:
Envel PANEL SYSTEM S175

DRAWN BY: SS	DATE: 4/11/16	REV.	SCALE: 1:2
-----------------	------------------	------	---------------

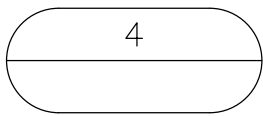
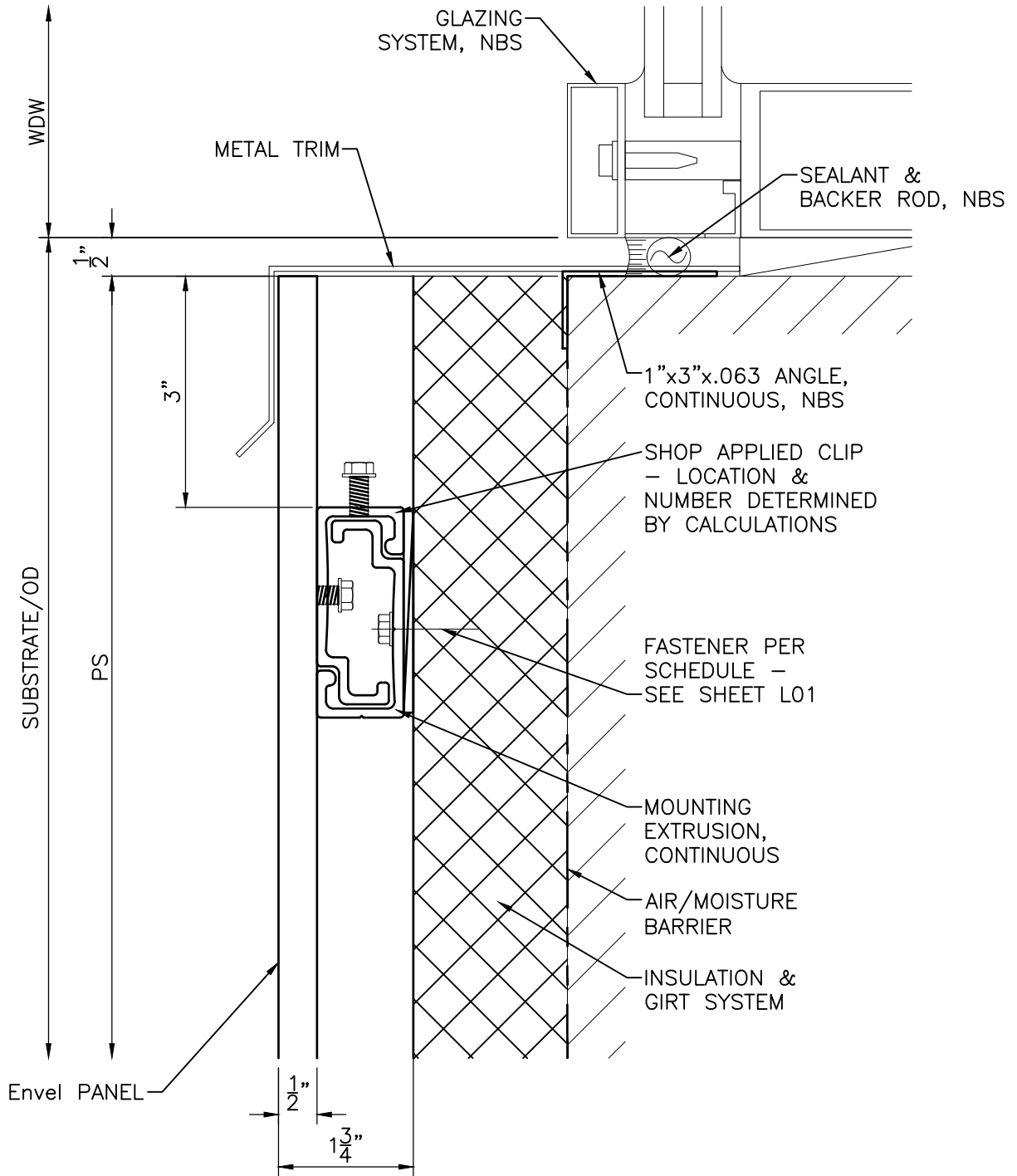

TYPICAL GLAZING SILL



TITLE:
Envel PANEL SYSTEM S175

DRAWN BY: SS	DATE: 4/11/16	REV.	SCALE: 1:2
-----------------	------------------	------	---------------

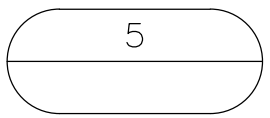
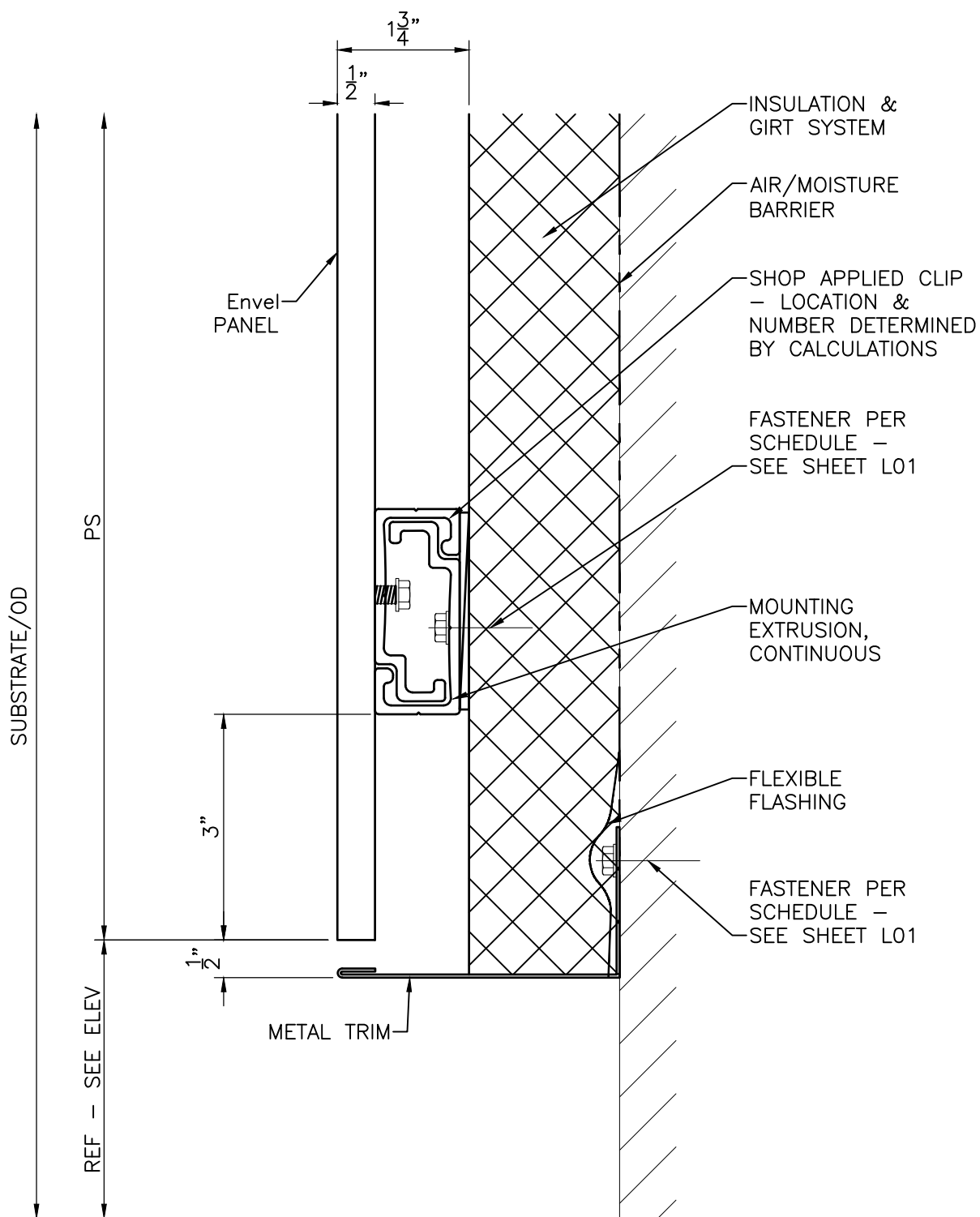

TYPICAL SILL (EXPOSED)



TITLE:
Envel PANEL SYSTEM S175

DRAWN BY: SS	DATE: 4/11/16	REV.	SCALE: 1:2
-----------------	------------------	------	---------------

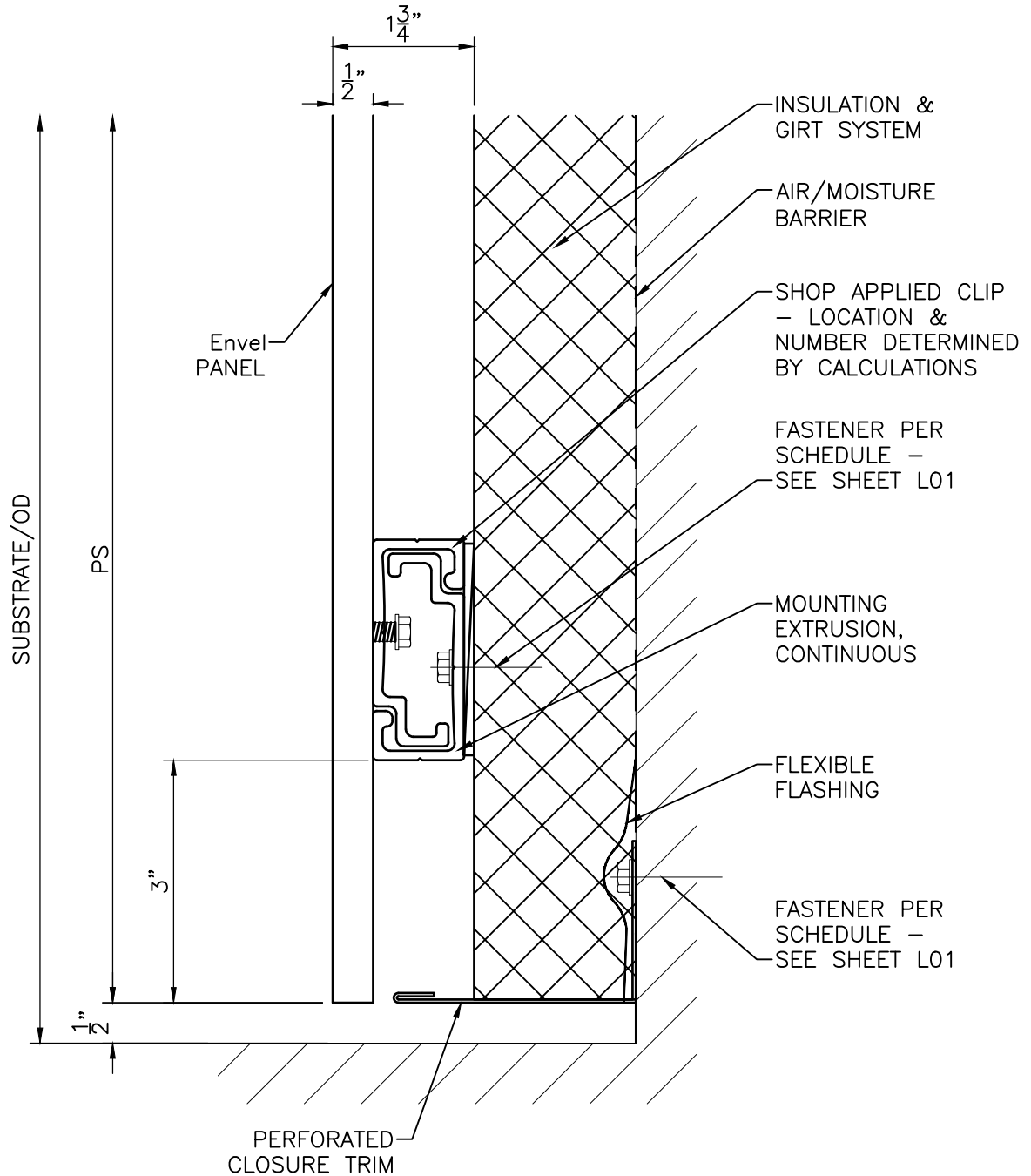

5A

TYPICAL PANEL BASE



TITLE:
Envel PANEL SYSTEM S175

DRAWN BY:
 SS

DATE:
 4/11/16

REV.

SCALE:
 1:2

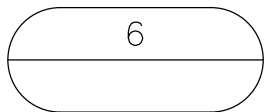
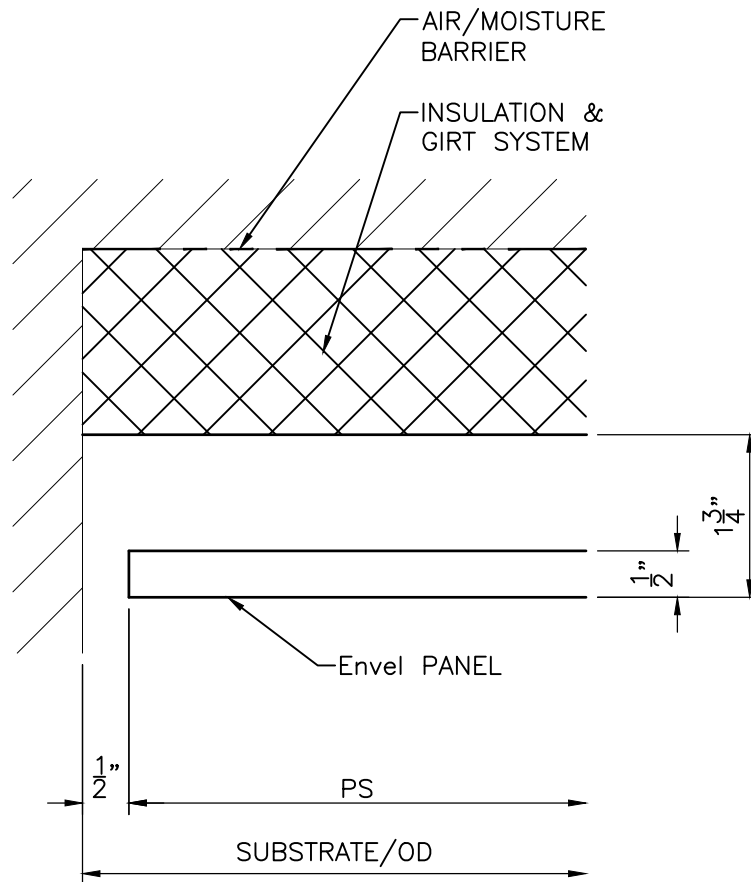

JAMB TERMINATION



TITLE:
Envel PANEL SYSTEM S175

DRAWN BY: SS	DATE: 4/11/16	REV.	SCALE: 1:2
-----------------	------------------	------	---------------

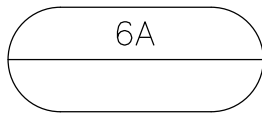
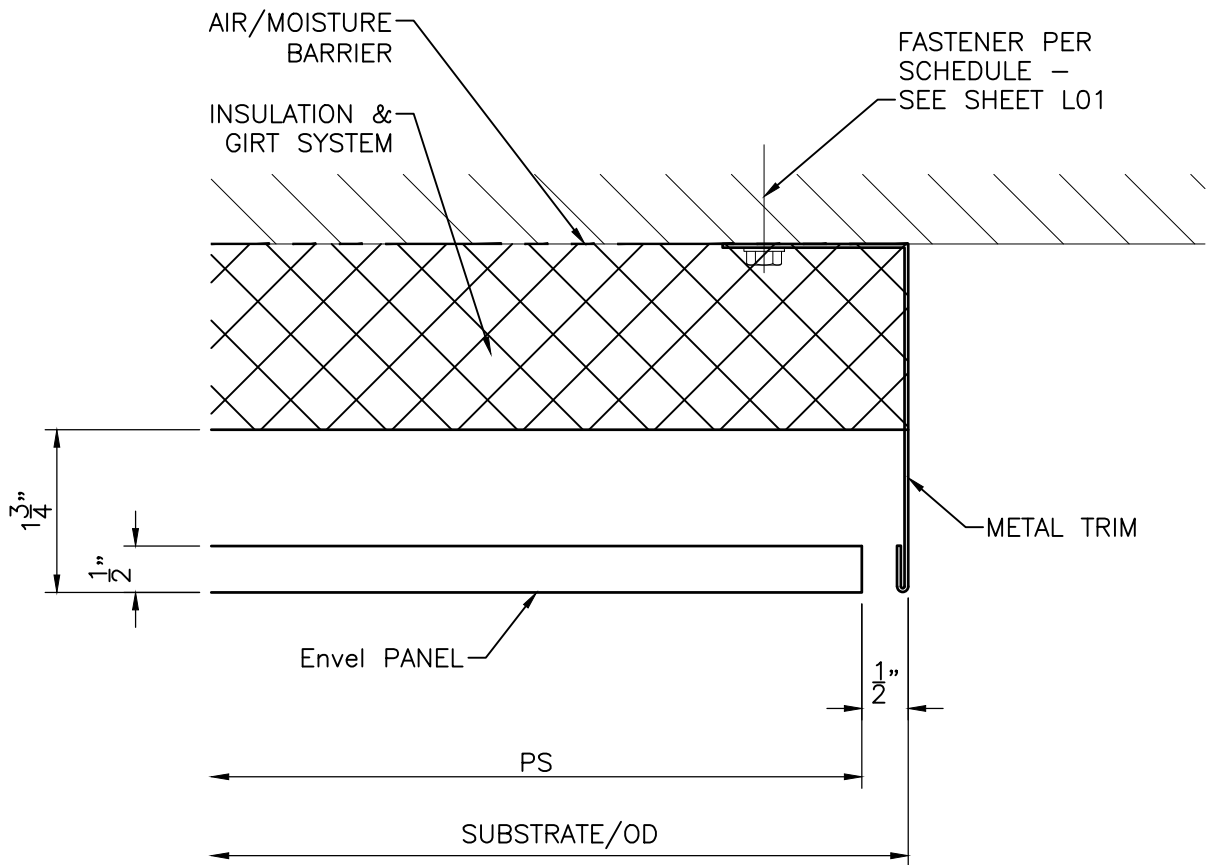

JAMB TERMINATION



TITLE:

Envel PANEL SYSTEM S175

DRAWN BY:
SS

DATE:
4/11/16

REV.

SCALE:
1:2

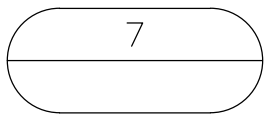
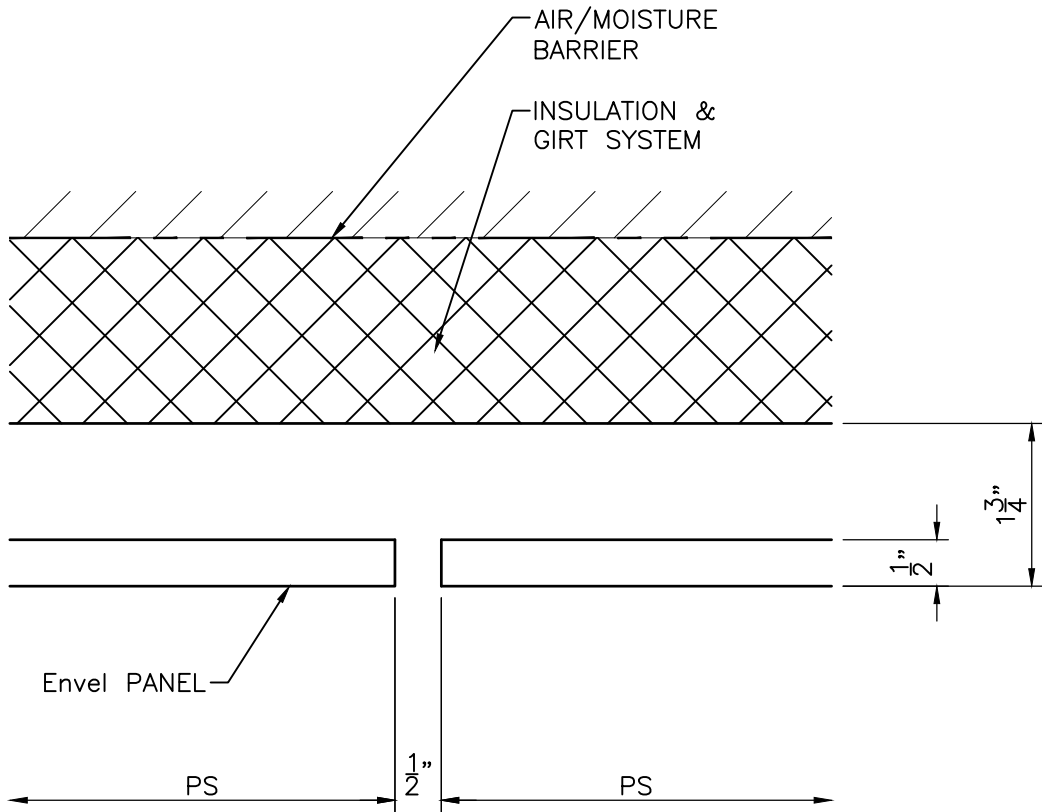

VERTICAL JOINT



TITLE:

Envel PANEL SYSTEM S175

DRAWN BY:
SS

DATE:
4/11/16

REV.

SCALE:
1:2

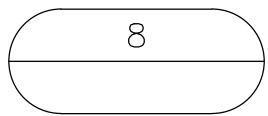
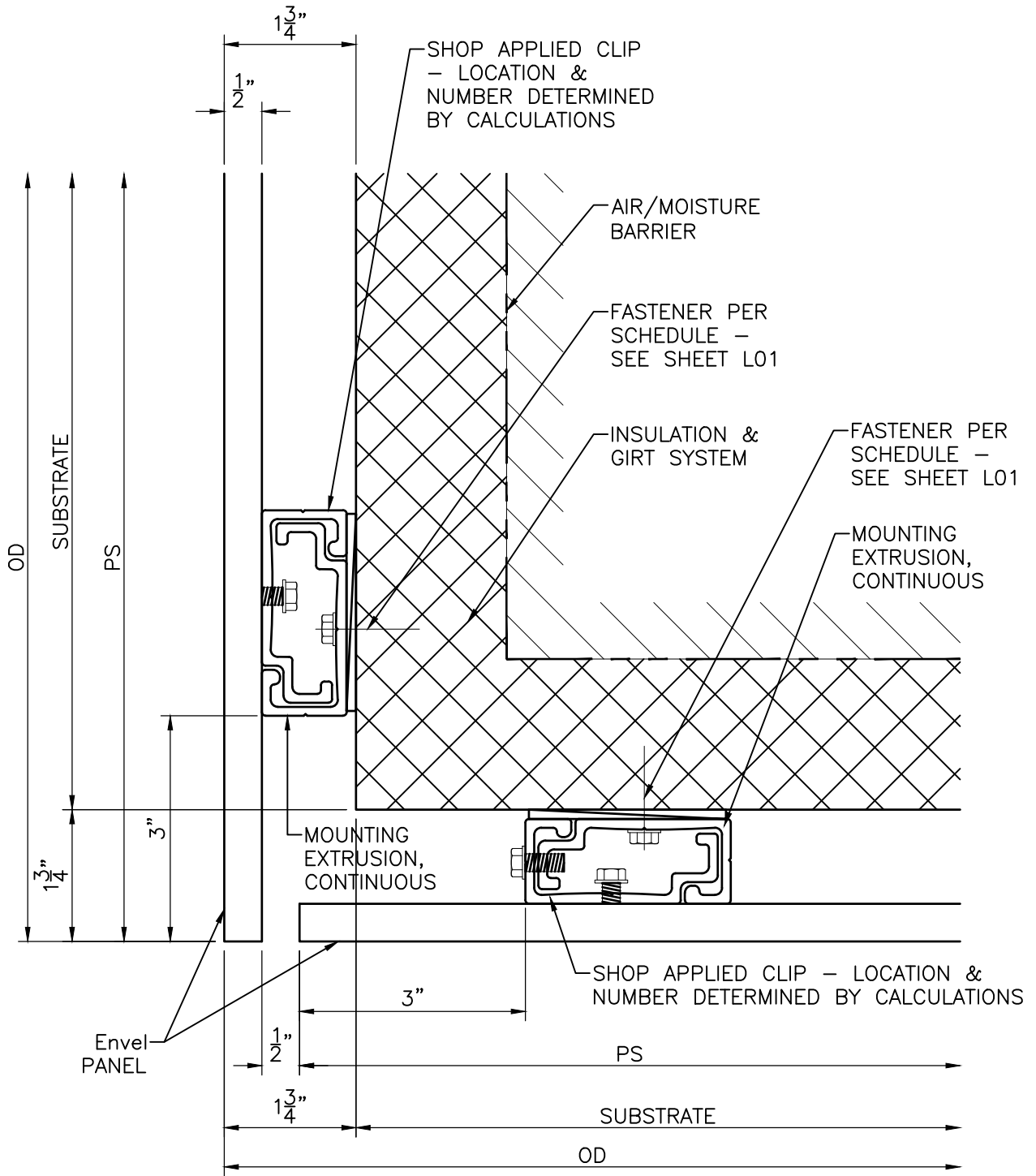

SOFFIT RETURN



TITLE:
Envel PANEL SYSTEM S175

DRAWN BY: SS	DATE: 4/11/16	REV.	SCALE: 1:2
-----------------	------------------	------	---------------

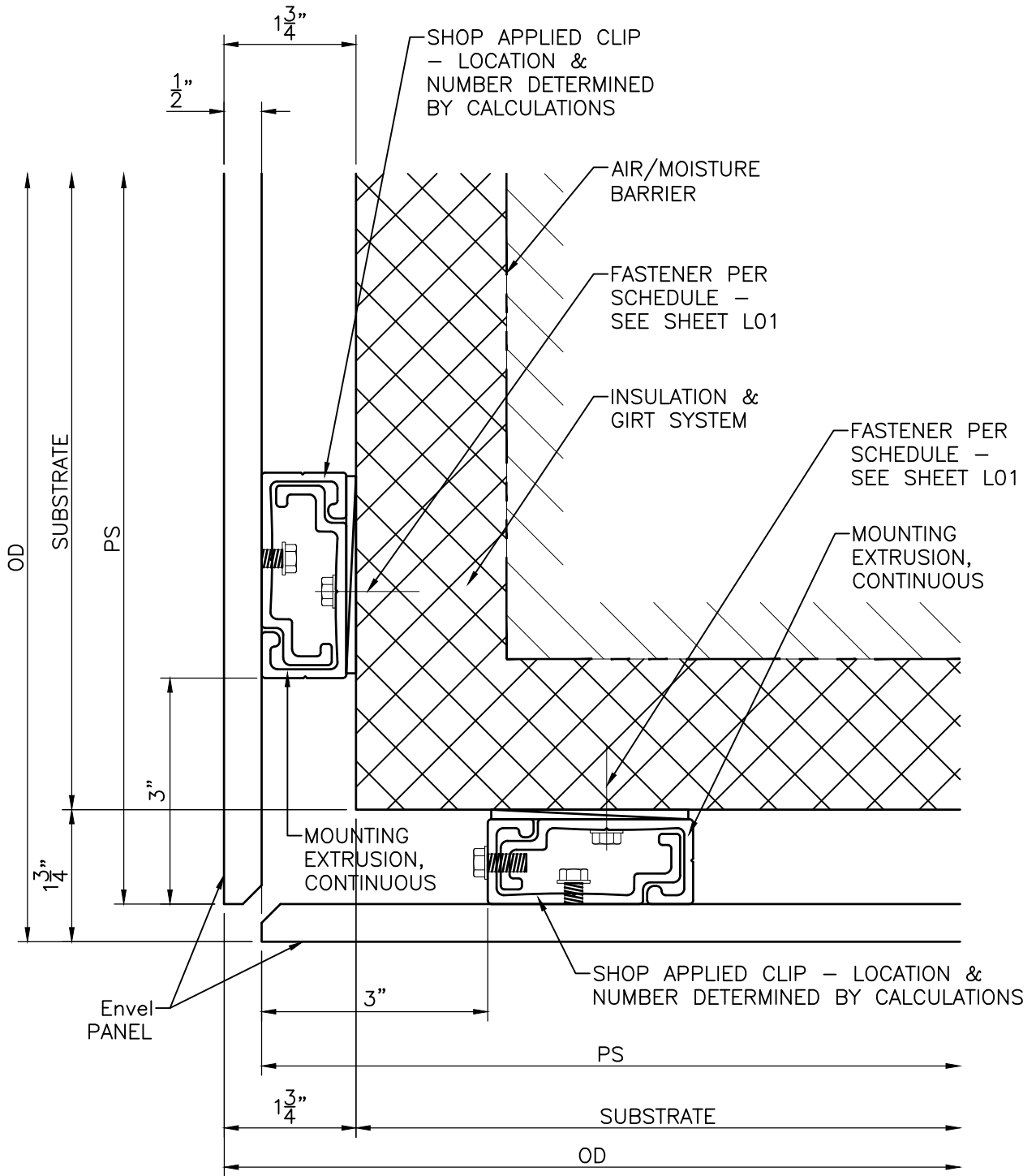

8A

SOFFIT RETURN



TITLE:
Envel PANEL SYSTEM S175

DRAWN BY: SS	DATE: 4/11/16	REV.	SCALE: 1:2
-----------------	------------------	------	---------------

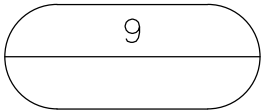
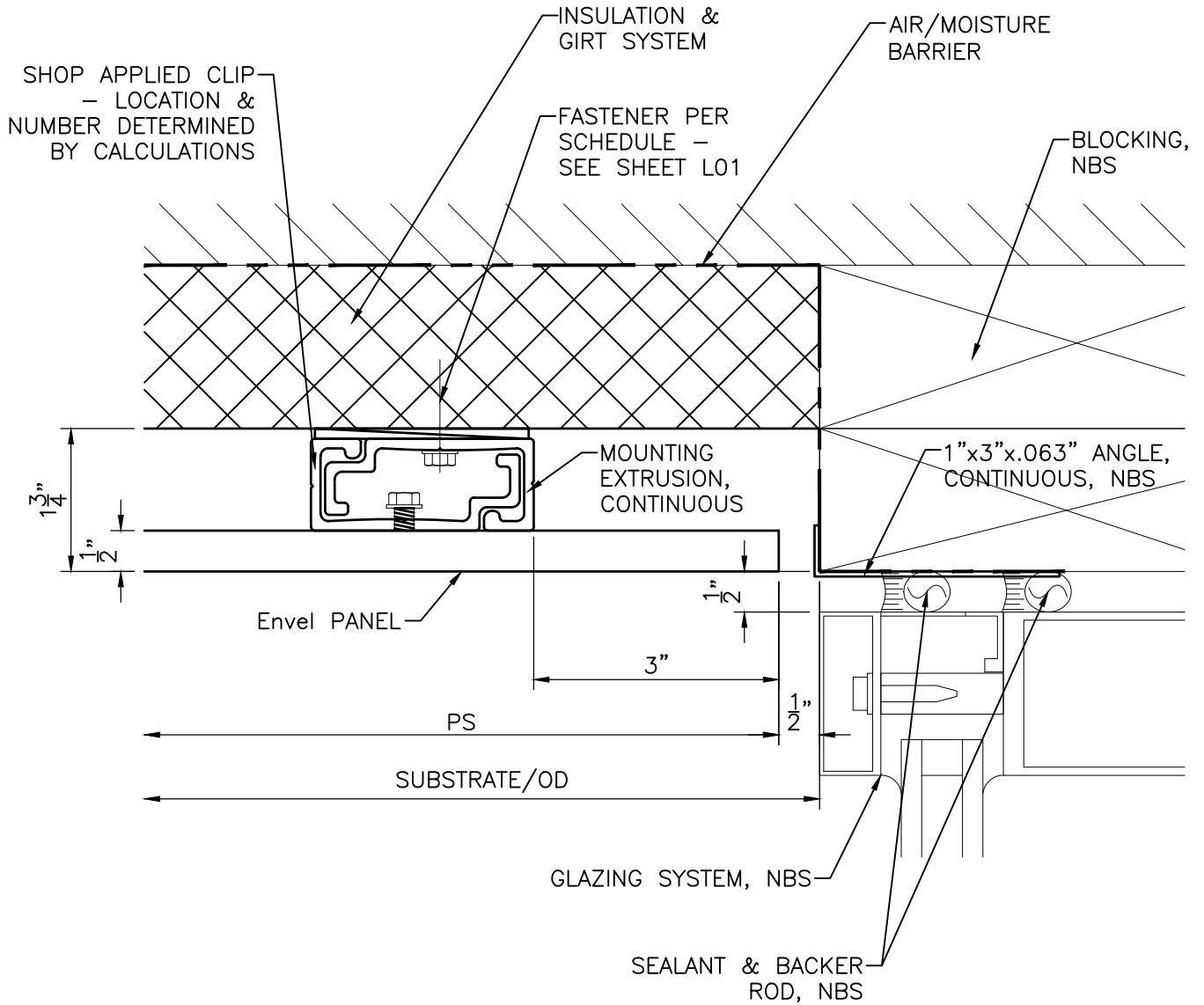

SOFFIT RETURN TO GLAZING HEAD



TITLE:
Envel PANEL SYSTEM S175

DRAWN BY:
SS

DATE:
4/11/16

REV.

SCALE:
1:2

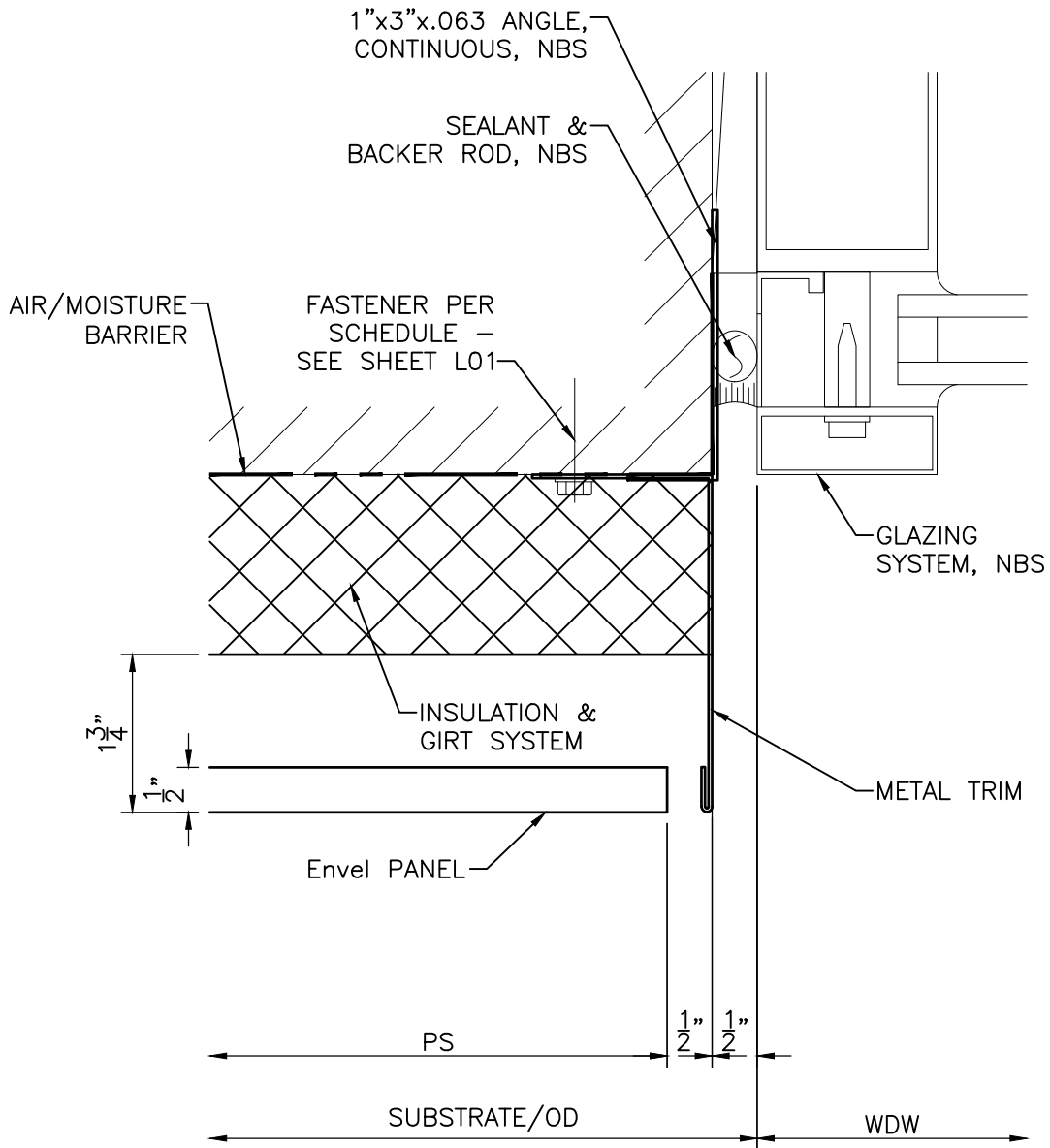

TYPICAL GLAZING JAMB



TITLE:

Envel PANEL SYSTEM S175

DRAWN BY:
SS

DATE:
4/11/16

REV.

SCALE:
1:2

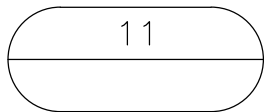
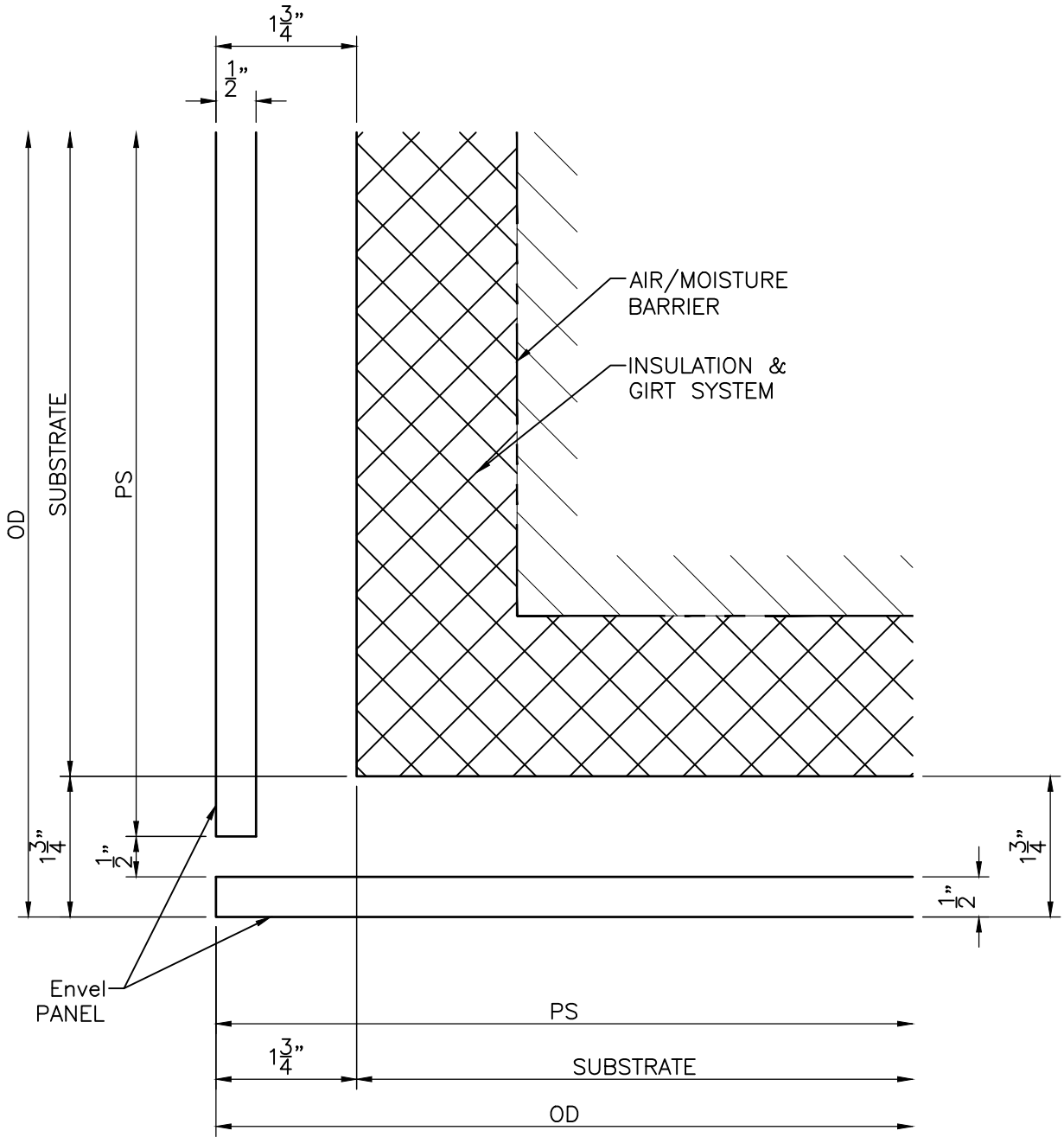

OUTSIDE CORNER (PLAN VIEW)



TITLE:

Envel PANEL SYSTEM S175

DRAWN BY:
SS

DATE:
4/11/16

REV.

SCALE:
1:2

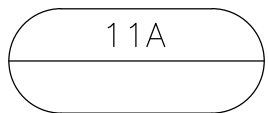
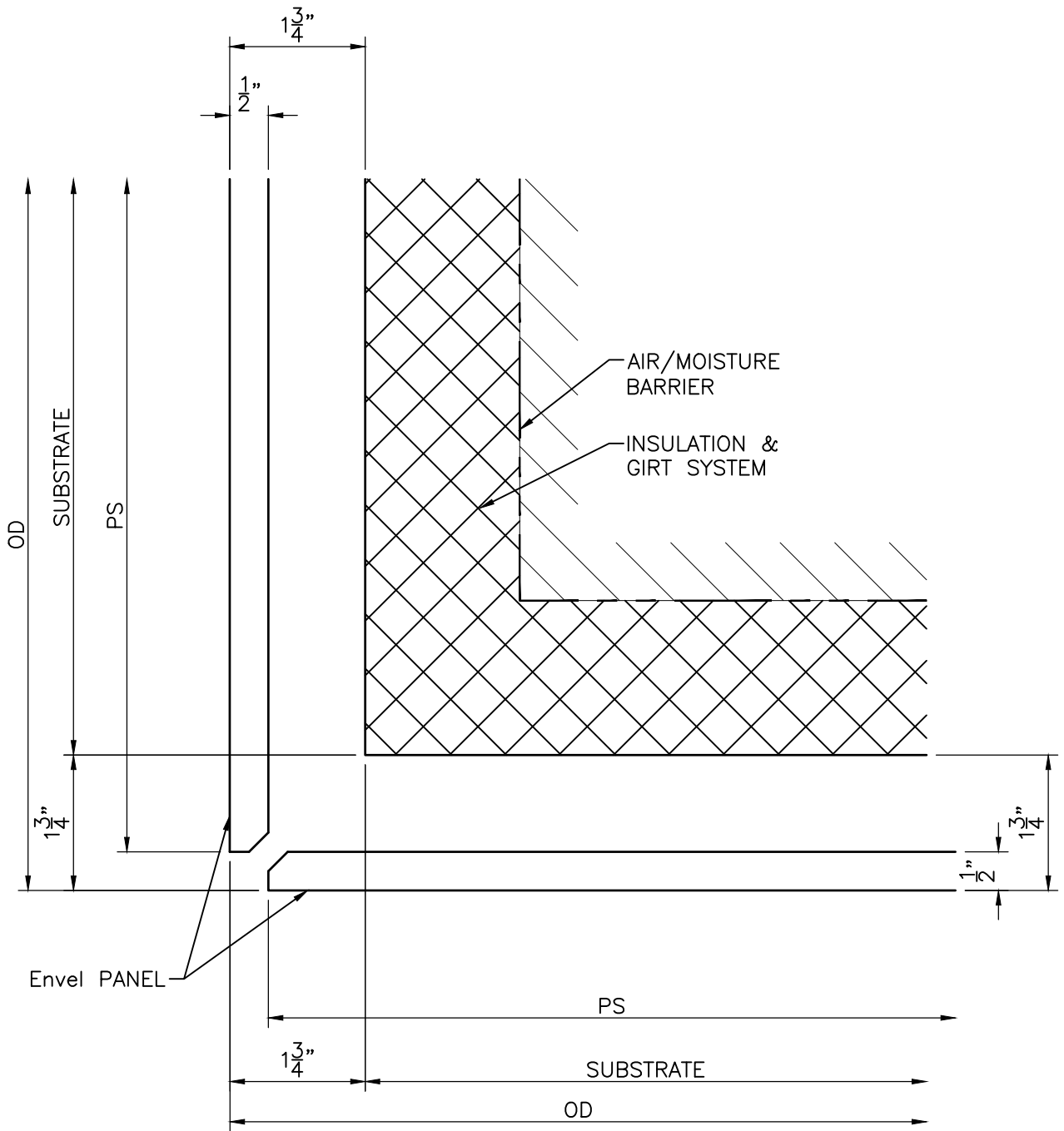

OUTSIDE CORNER (PLAN VIEW)



TITLE:

Envel PANEL SYSTEM S175

DRAWN BY:
SS

DATE:
4/11/16

REV.

SCALE:
1:2

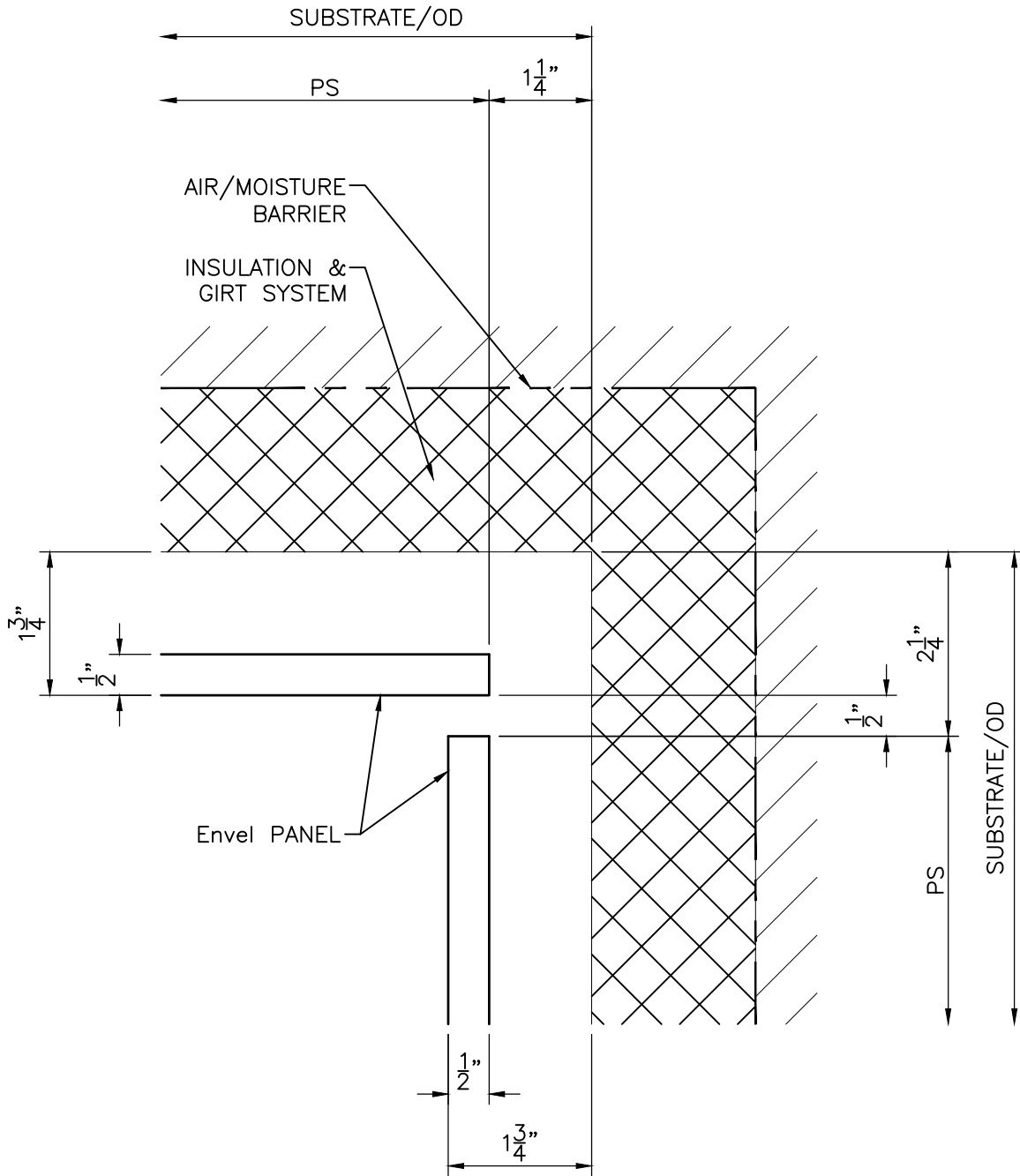

INSIDE CORNER (PLAN VIEW)



TITLE:

Envel PANEL SYSTEM S175

DRAWN BY:
SS

DATE:
4/11/16

REV.

SCALE:
1:2