

Envel PANEL SYSTEM PROMOTIONAL DETAILS

MANUFACTURER'S SPECIFICATION AND DETAILS SUBJECT TO CHANGE WITHOUT NOTICE



TITLE:

Envel PANEL SYSTEM

DRAWN BY:
SS/KAM

DATE:
4/8/16

REV.

SCALE:
FULL

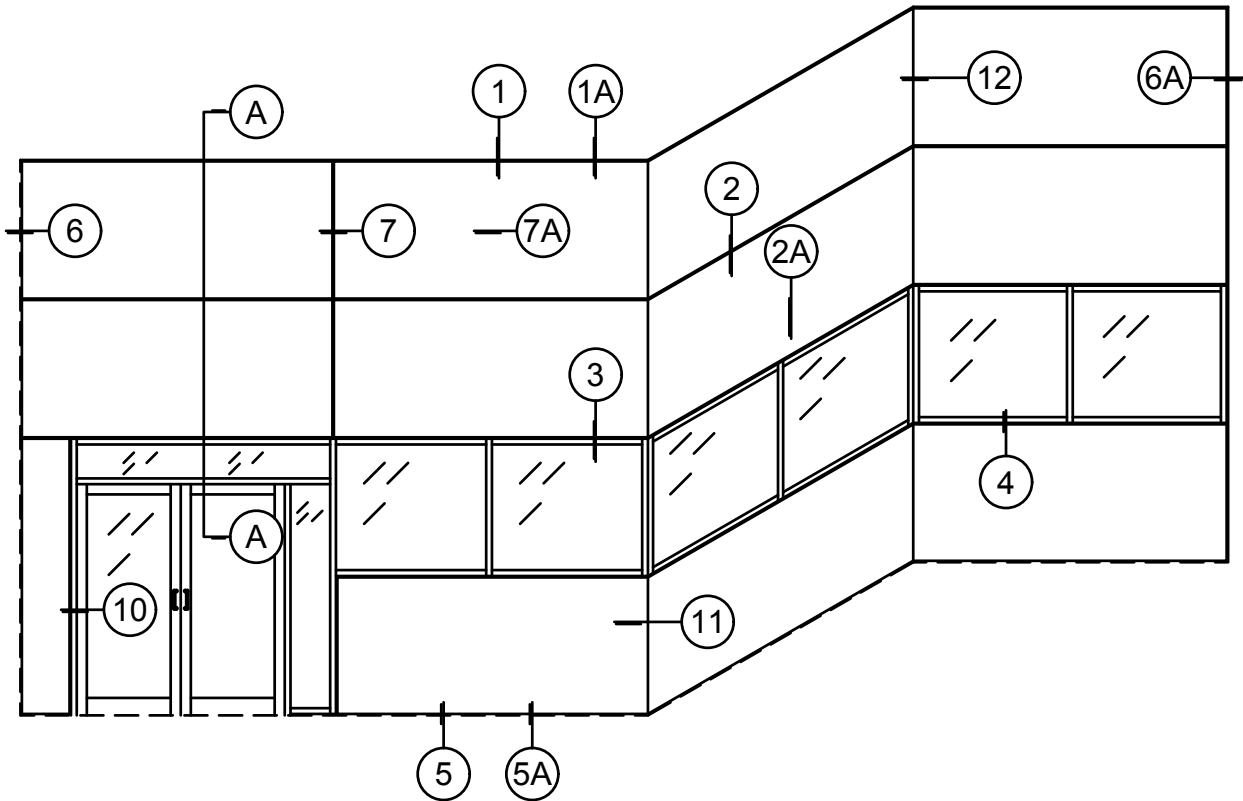

ELEVATION

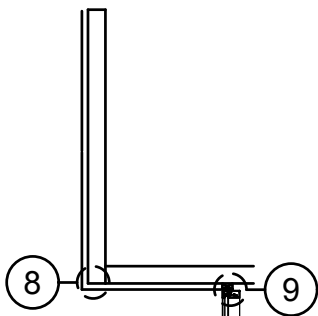

SECTION A-A



TITLE:

Envel PANEL SYSTEM

DRAWN BY:
SS/KAM

DATE:
4/8/16

REV.

SCALE:
3/16" = 1'-0"

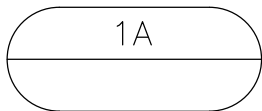
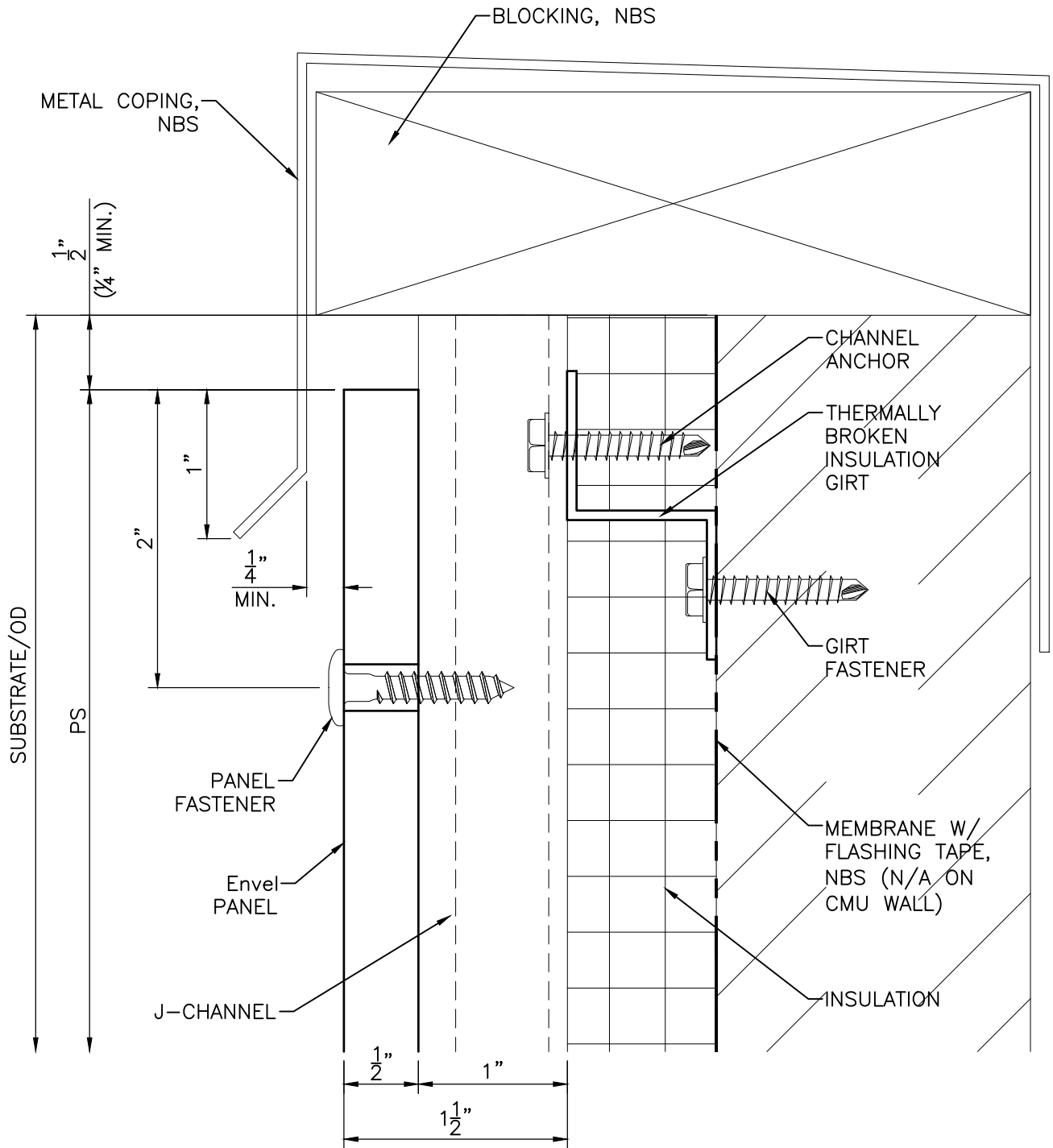

UPPER TERMINATION @ COPING



TITLE:

Envel PANEL SYSTEM

DRAWN BY:
SS/KAM

DATE:
4/8/16

REV.

SCALE:
FULL

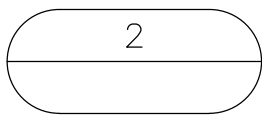
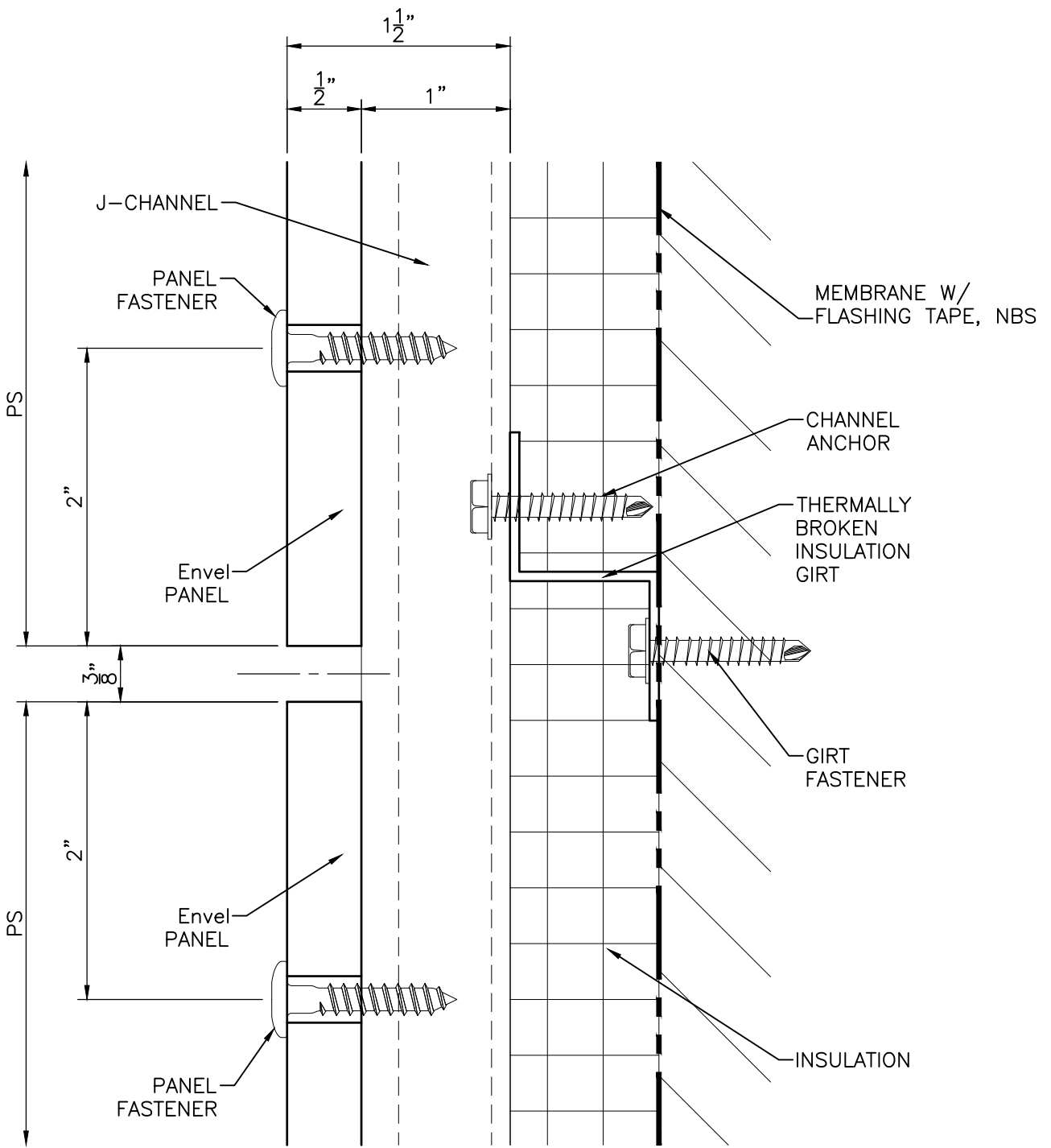

TYPICAL HORIZONTAL JOINT



TITLE:

Envel PANEL SYSTEM

DRAWN BY:
SS/KAM

DATE:
4/8/16

REV.

SCALE:
FULL

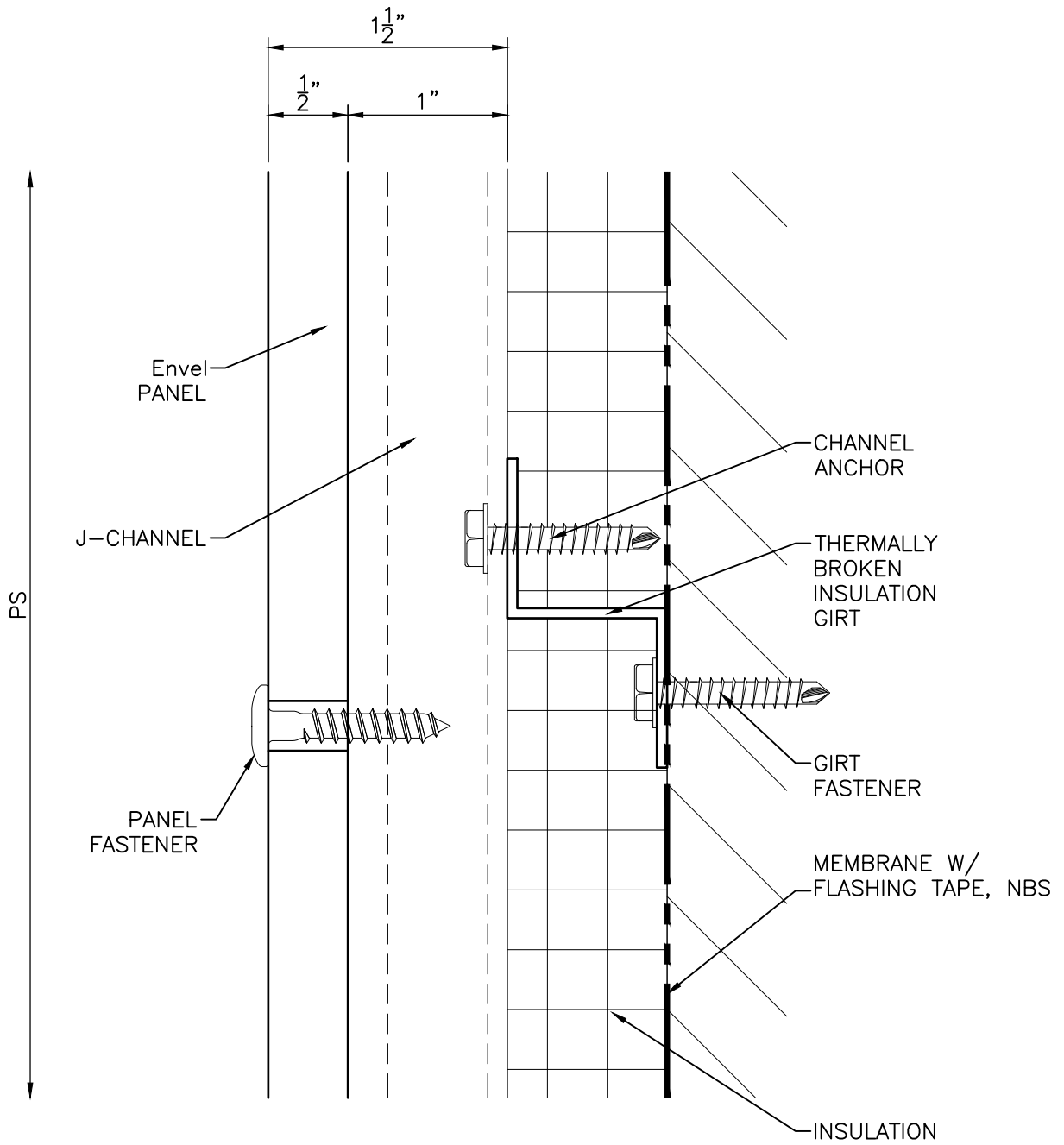

2A

HORIZONTAL (MID PANEL)



TITLE:

Envel PANEL SYSTEM

DRAWN BY:
SS/KAM

DATE:
4/8/16

REV.

SCALE:
FULL

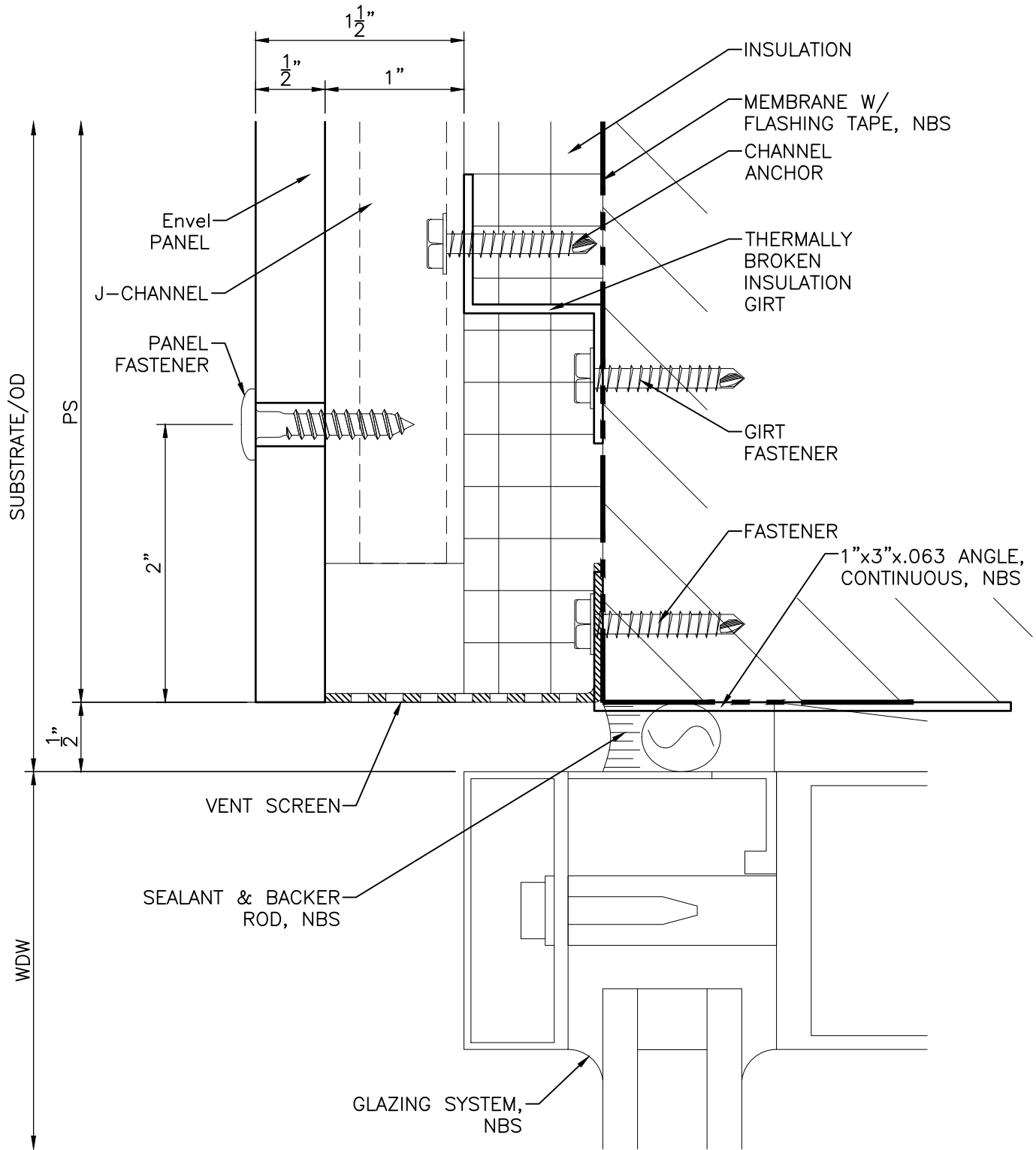

TYPICAL GLAZING HEAD



TITLE:

Envel PANEL SYSTEM

DRAWN BY:
SS/KAM

DATE:
4/8/16

REV.

SCALE:
FULL

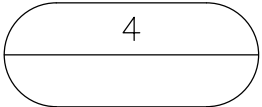
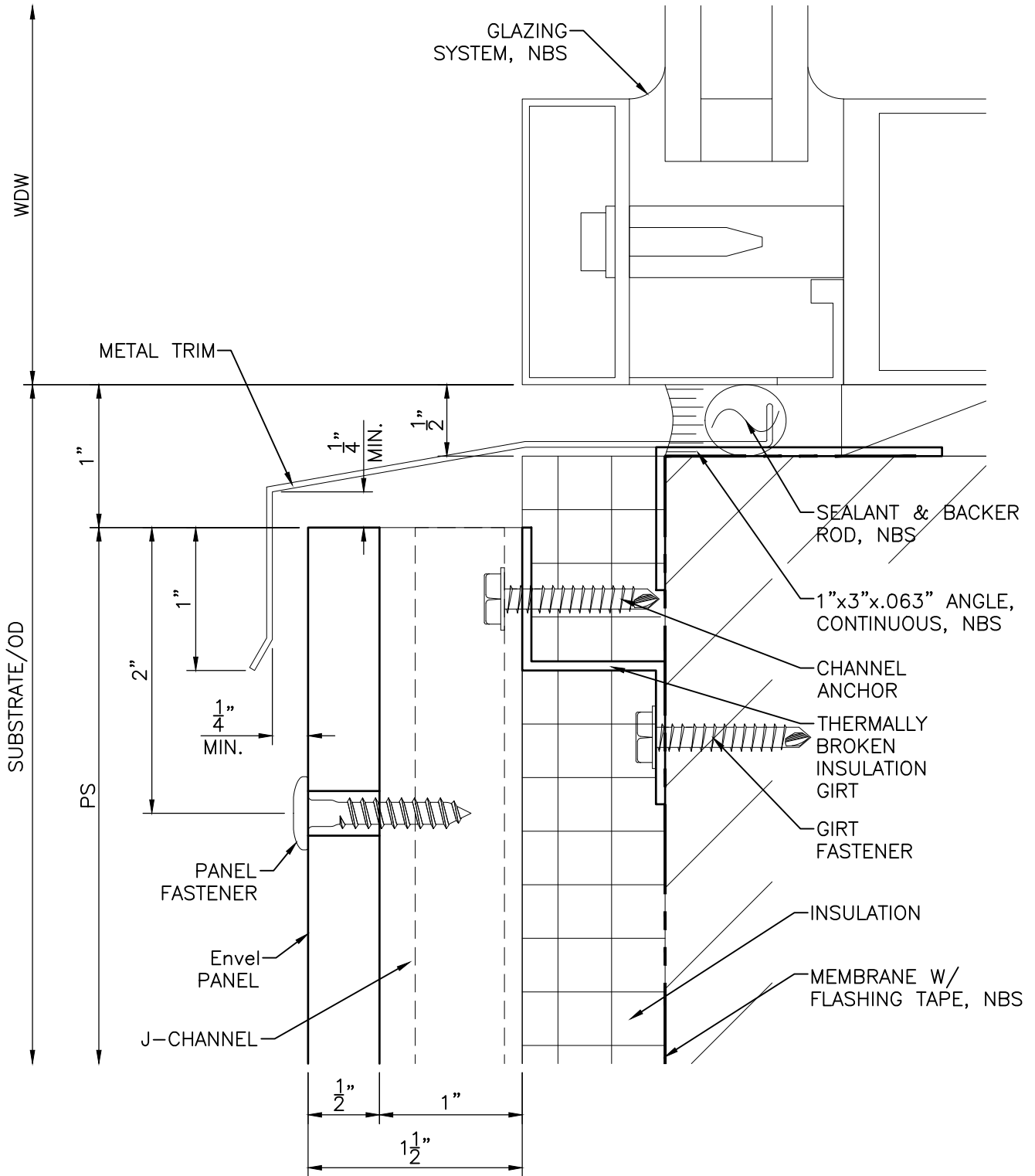

TYPICAL GLAZING SILL



TITLE:
Envel PANEL SYSTEM

DRAWN BY:
 SS/KAM

DATE:
 4/8/16

REV.

SCALE:
 FULL

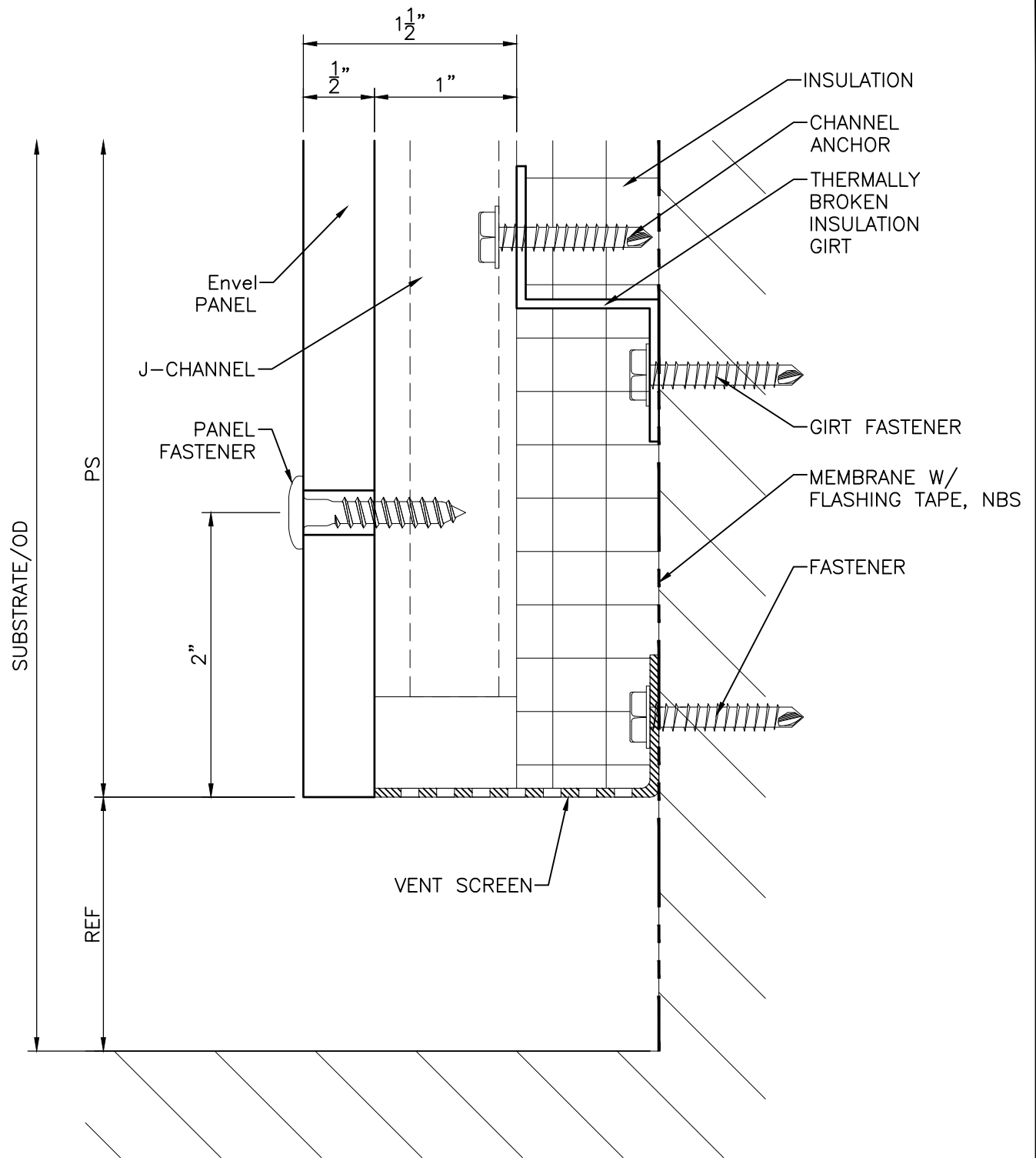

TYPICAL BASE (EXPOSED)



TITLE:

Envel PANEL SYSTEM

DRAWN BY:
SS/KAM

DATE:
4/8/16

REV.

SCALE:
FULL

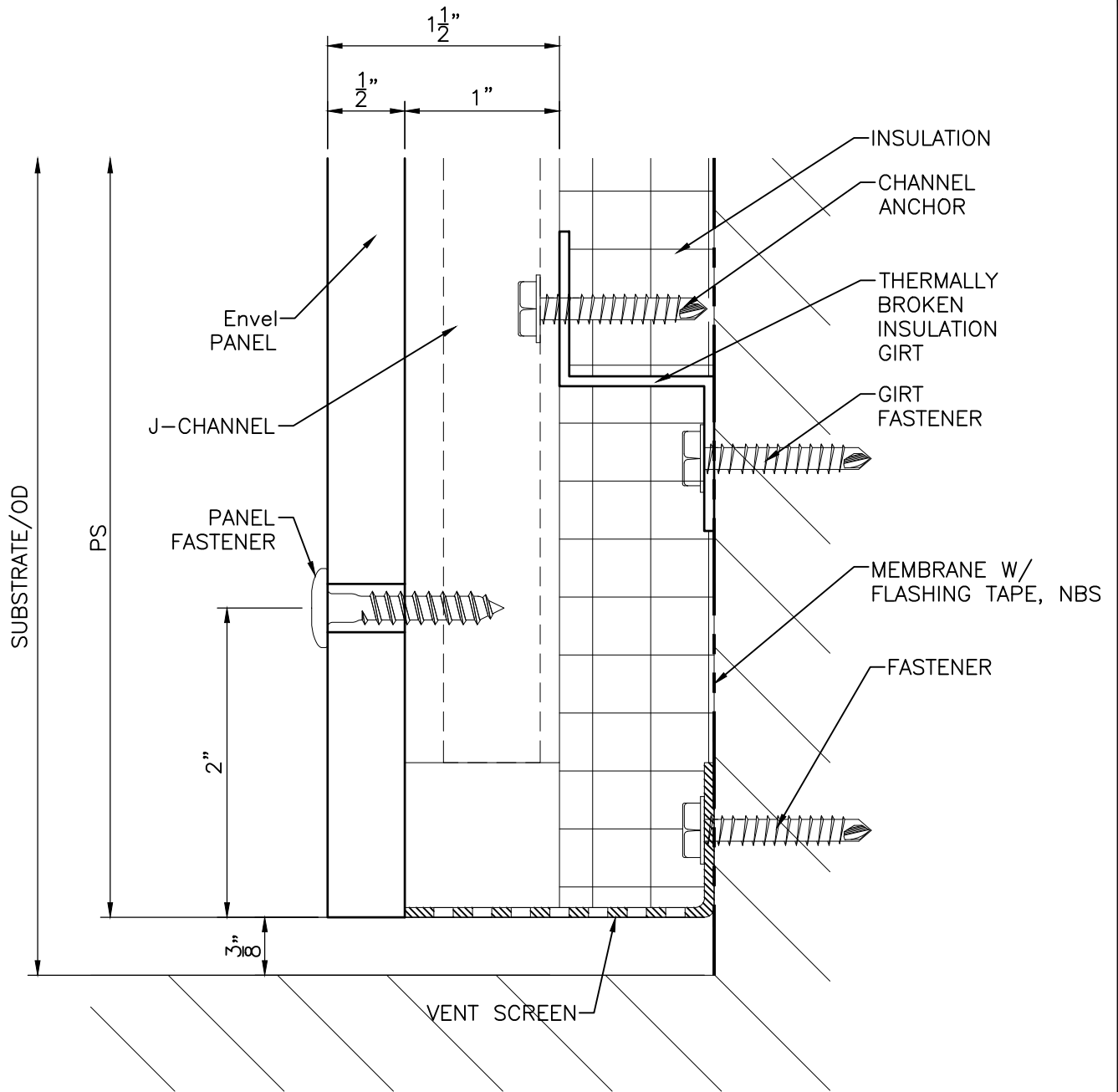

5A

TYPICAL PANEL BASE



TITLE:

Envel PANEL SYSTEM

DRAWN BY:
SS/KAM

DATE:
4/8/16

REV.

SCALE:
FULL

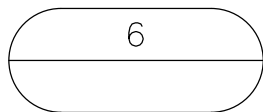
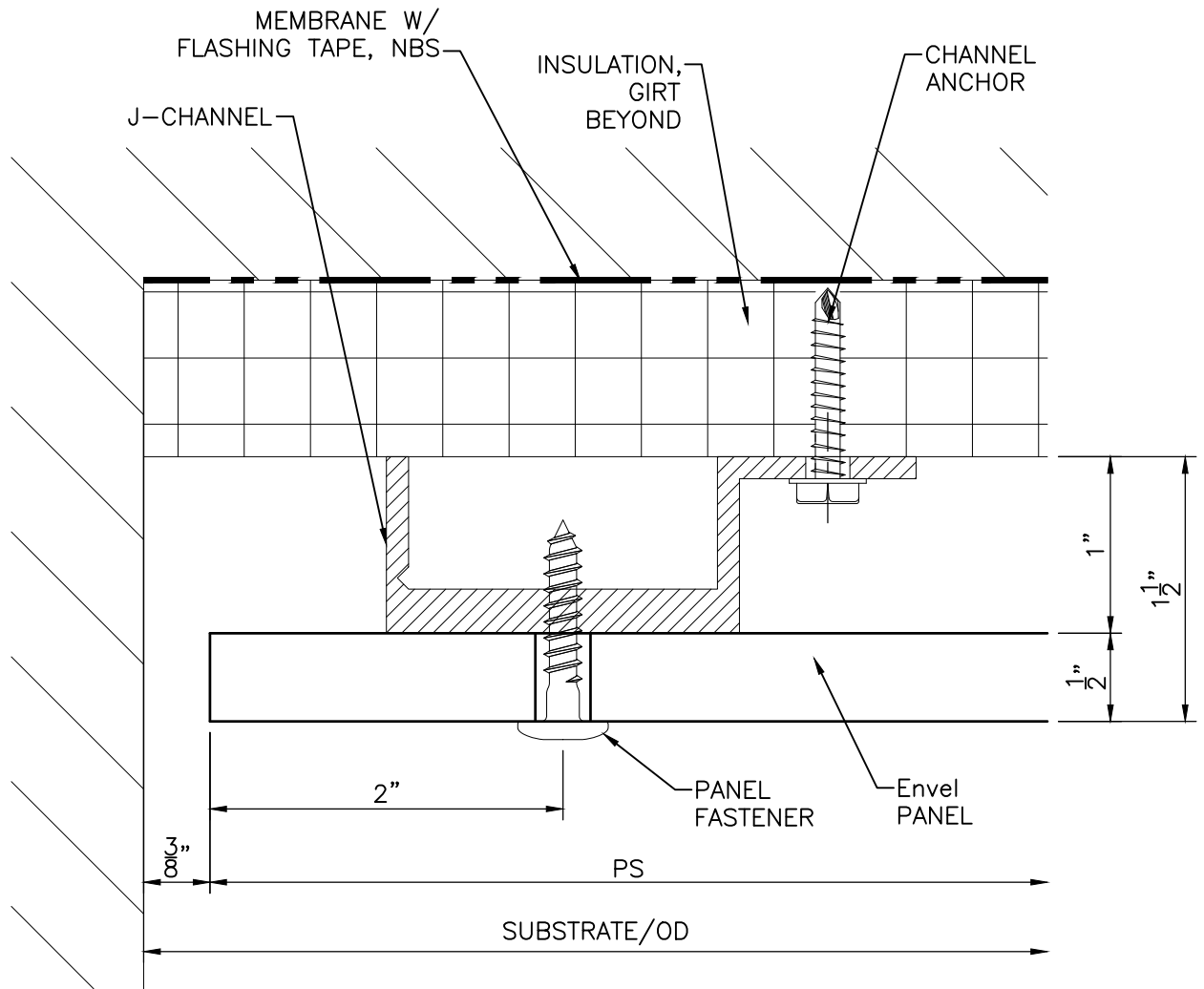

JAMB TERMINATION



TITLE:

Envel PANEL SYSTEM

DRAWN BY:
SS/KAM

DATE:
4/8/16

REV.

SCALE:
FULL

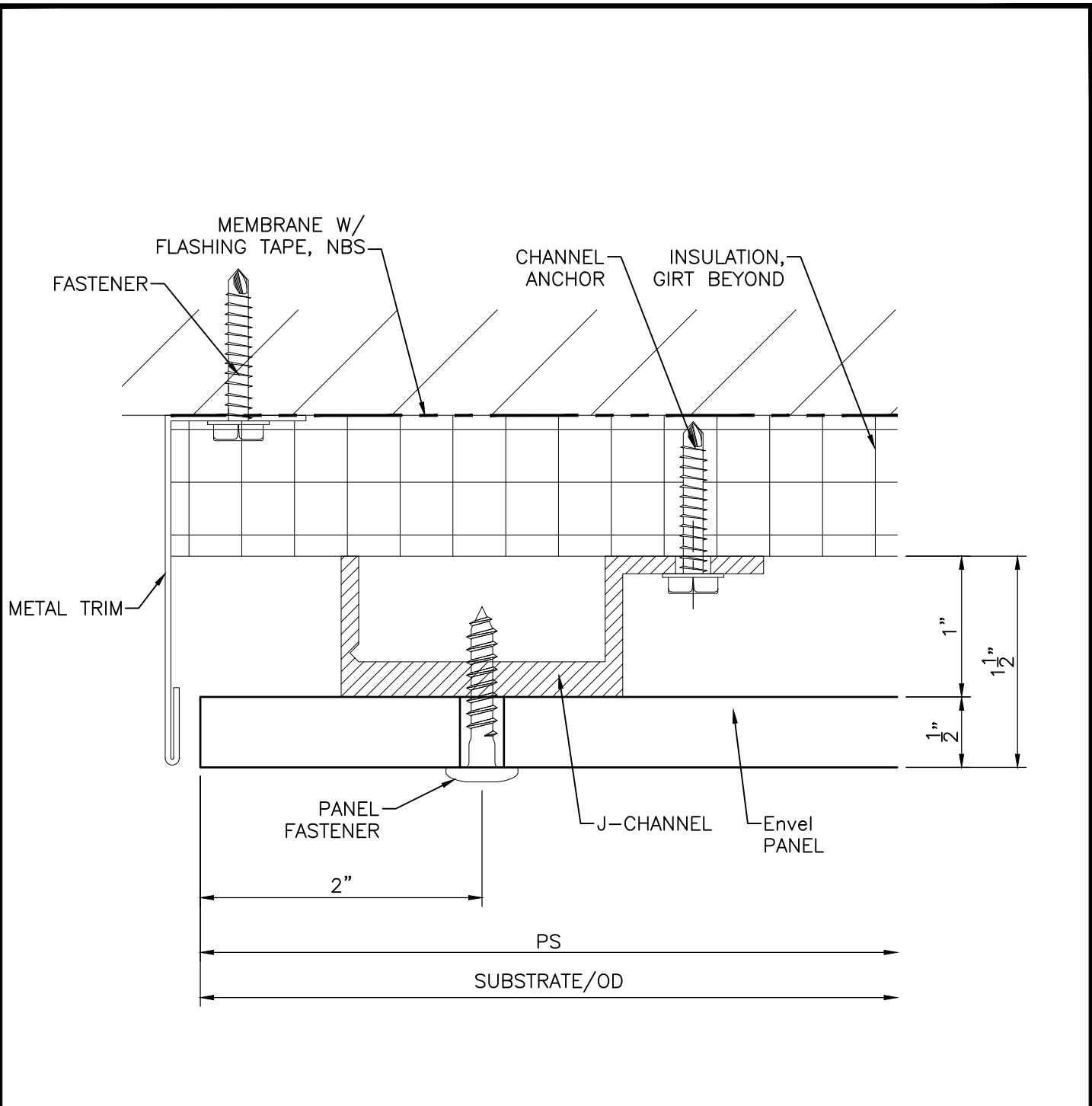

6A

JAMB TERMINATION



TITLE:
Envel PANEL SYSTEM

DRAWN BY:
SS/KAM

DATE:
4/8/16

REV.

SCALE:
FULL

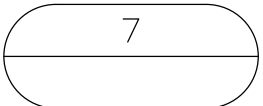
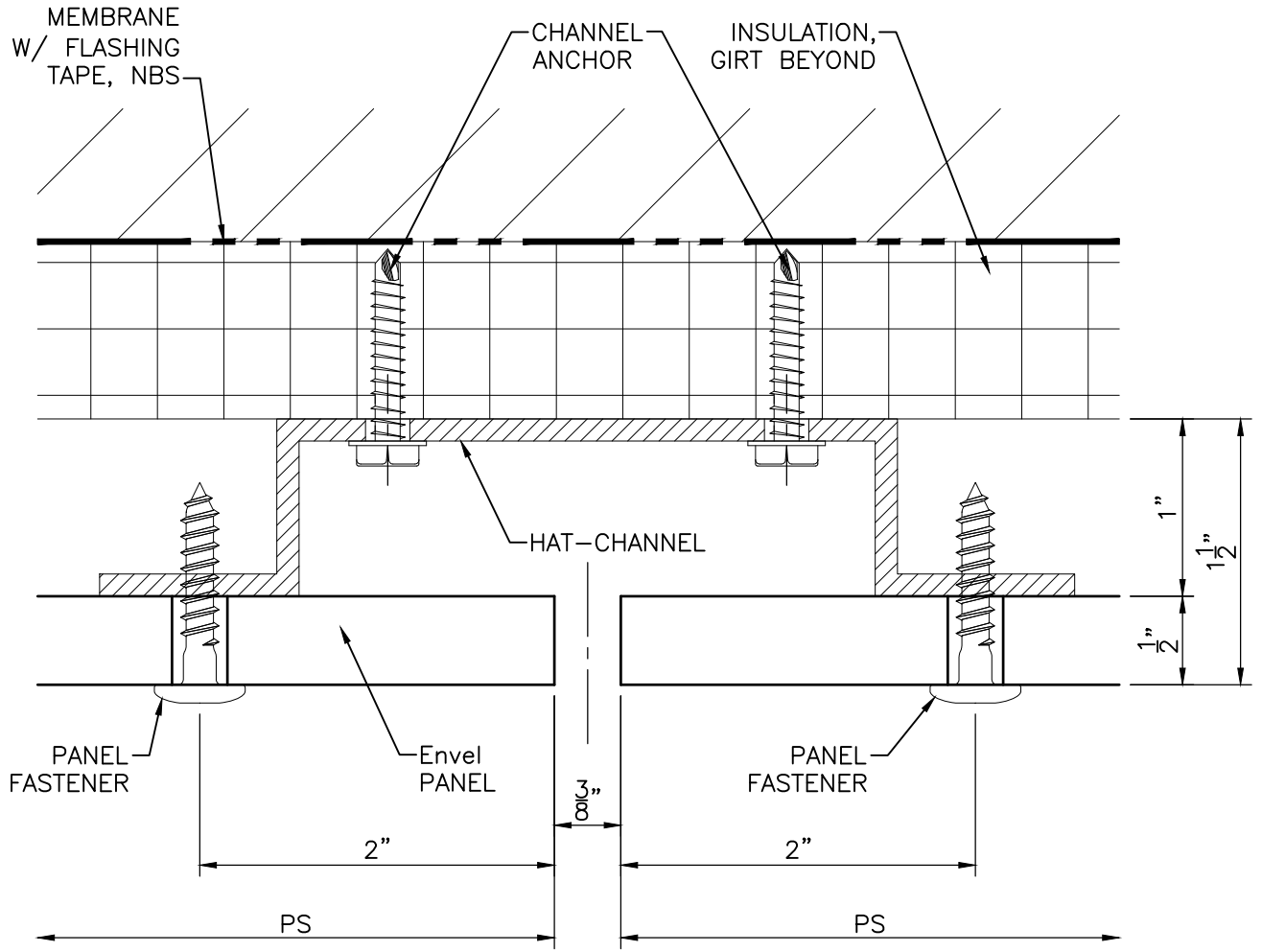

VERTICAL JOINT



TITLE:
Envel PANEL SYSTEM

DRAWN BY:
 SS/KAM

DATE:
 4/8/16

REV.

SCALE:
 FULL

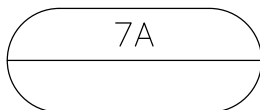
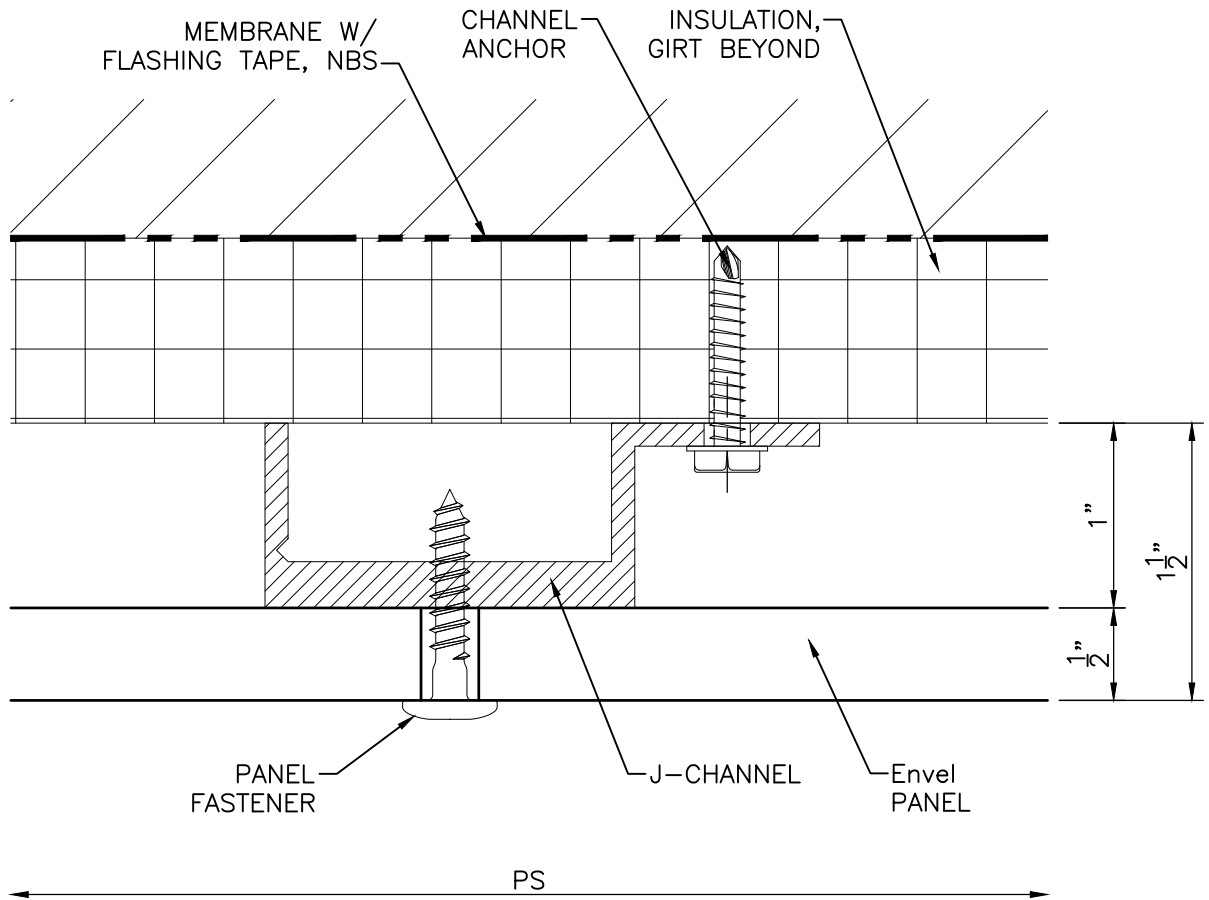

VERTICAL (MID PANEL)



TITLE:

Envel PANEL SYSTEM

DRAWN BY:
SS/KAM

DATE:
4/8/16

REV.

SCALE:
FULL

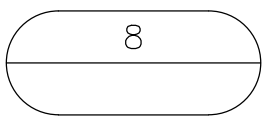
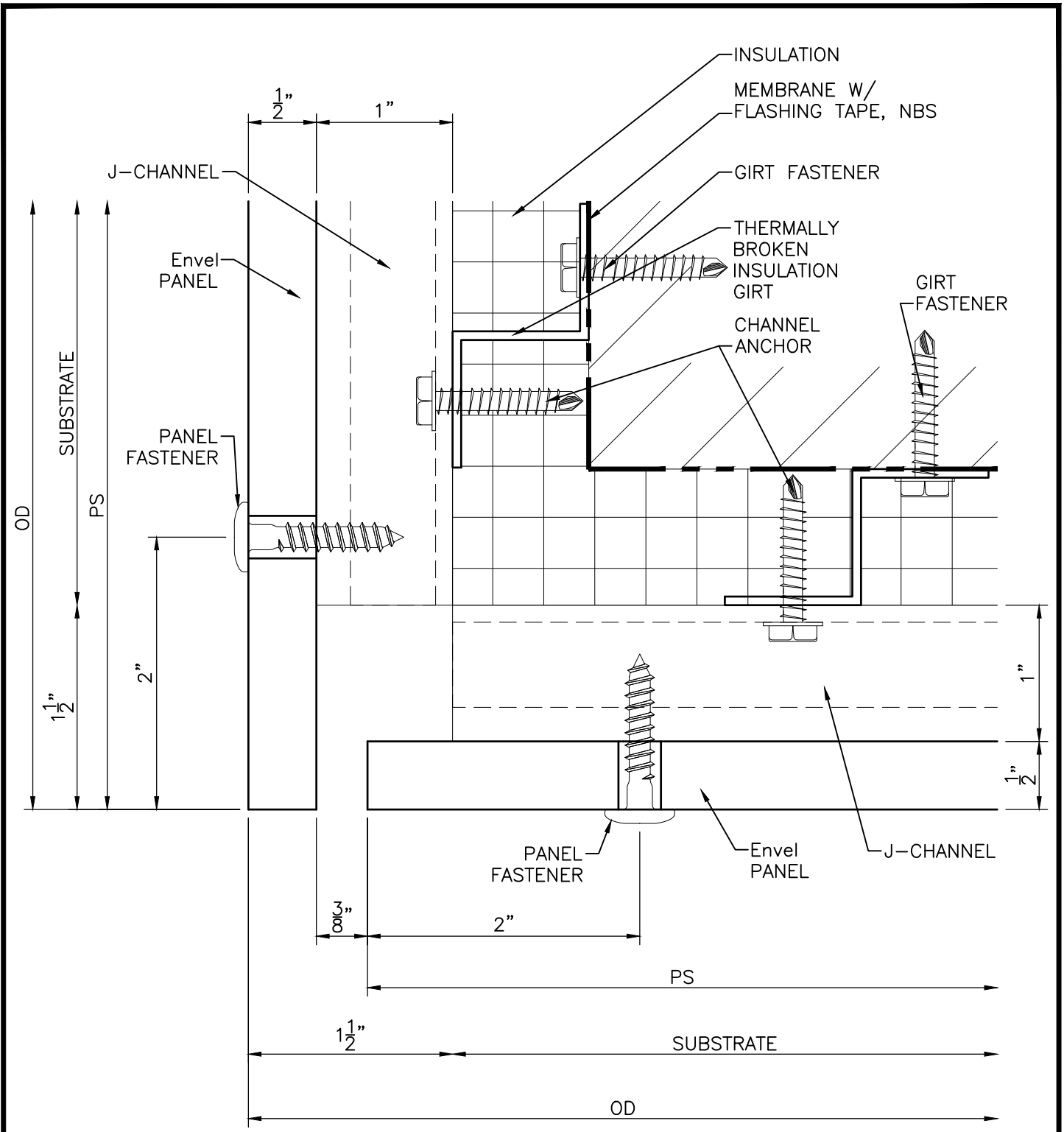

SOFFIT RETURN



TITLE:
Envel PANEL SYSTEM

DRAWN BY:
SS/KAM

DATE:
4/8/16

REV.

SCALE:
FULL

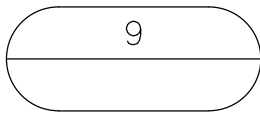
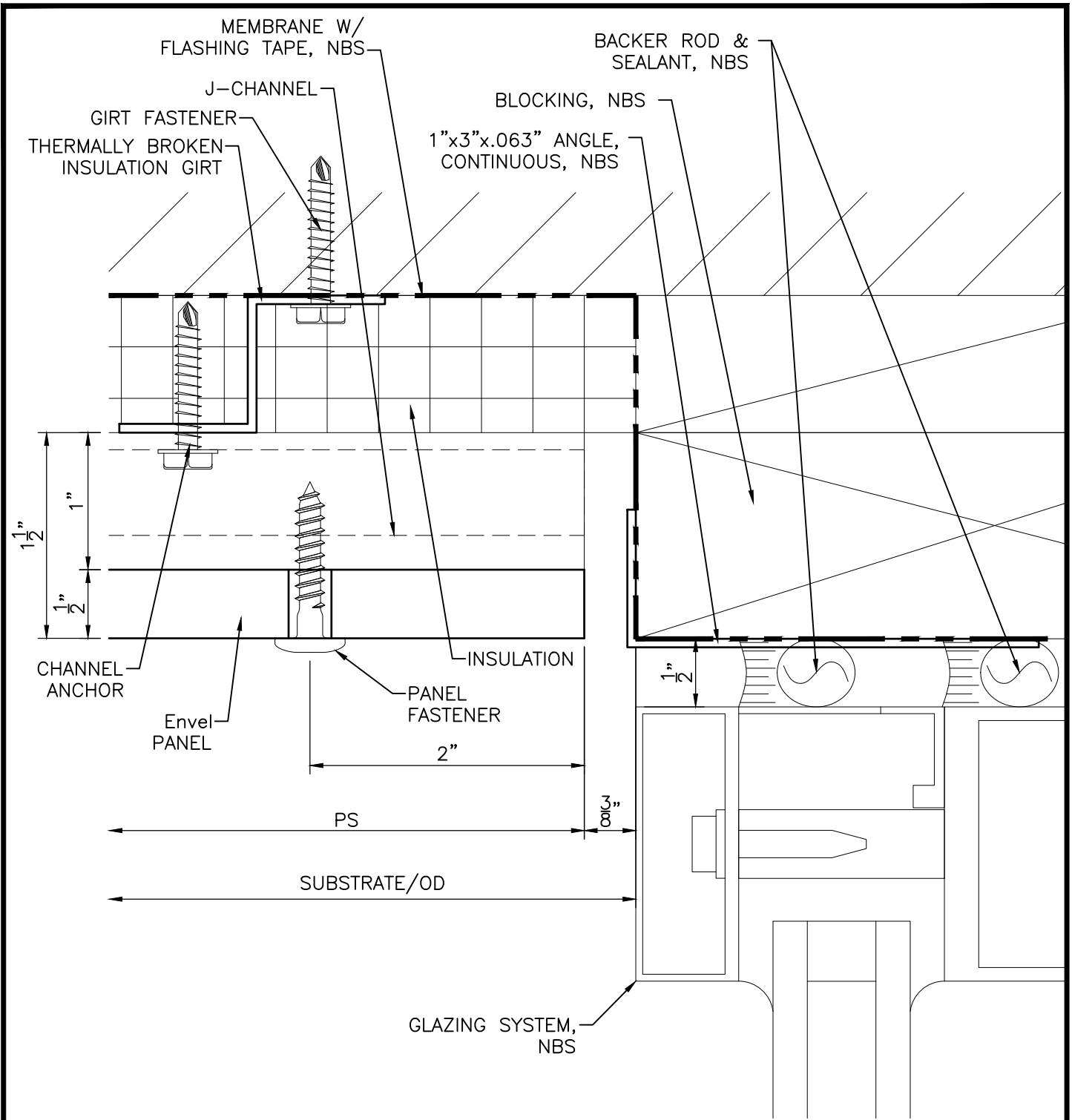

SOFFIT RETURN TO GLAZING HEAD



TITLE:

Envel PANEL SYSTEM

DRAWN BY:
SS/KAM

DATE:
4/8/16

REV.

SCALE:
FULL

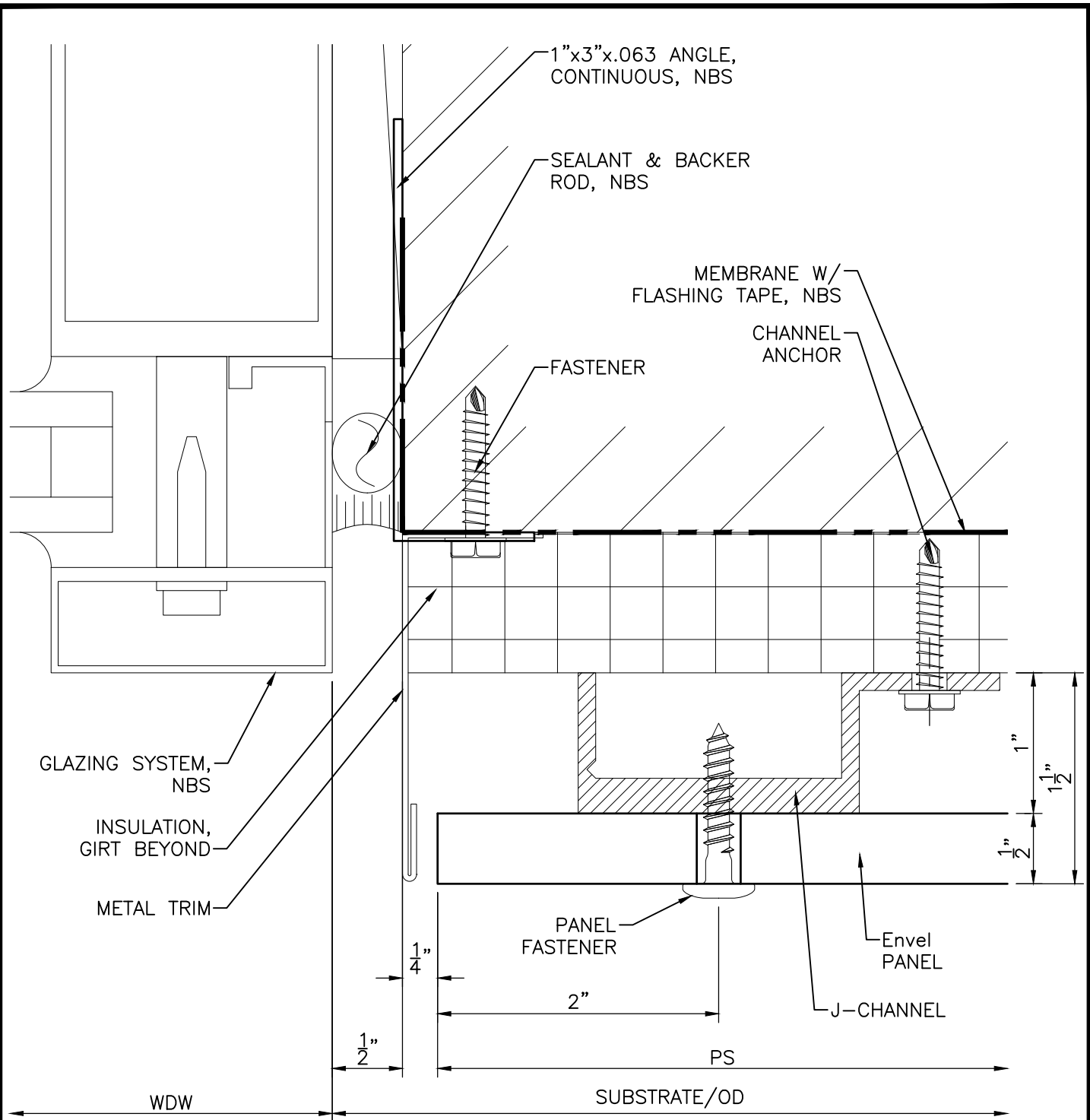

10

TYPICAL GLAZING JAMB



TITLE:

Envel PANEL SYSTEM

DRAWN BY:
SS/KAM

DATE:
4/8/16

REV.

SCALE:
FULL

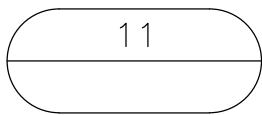
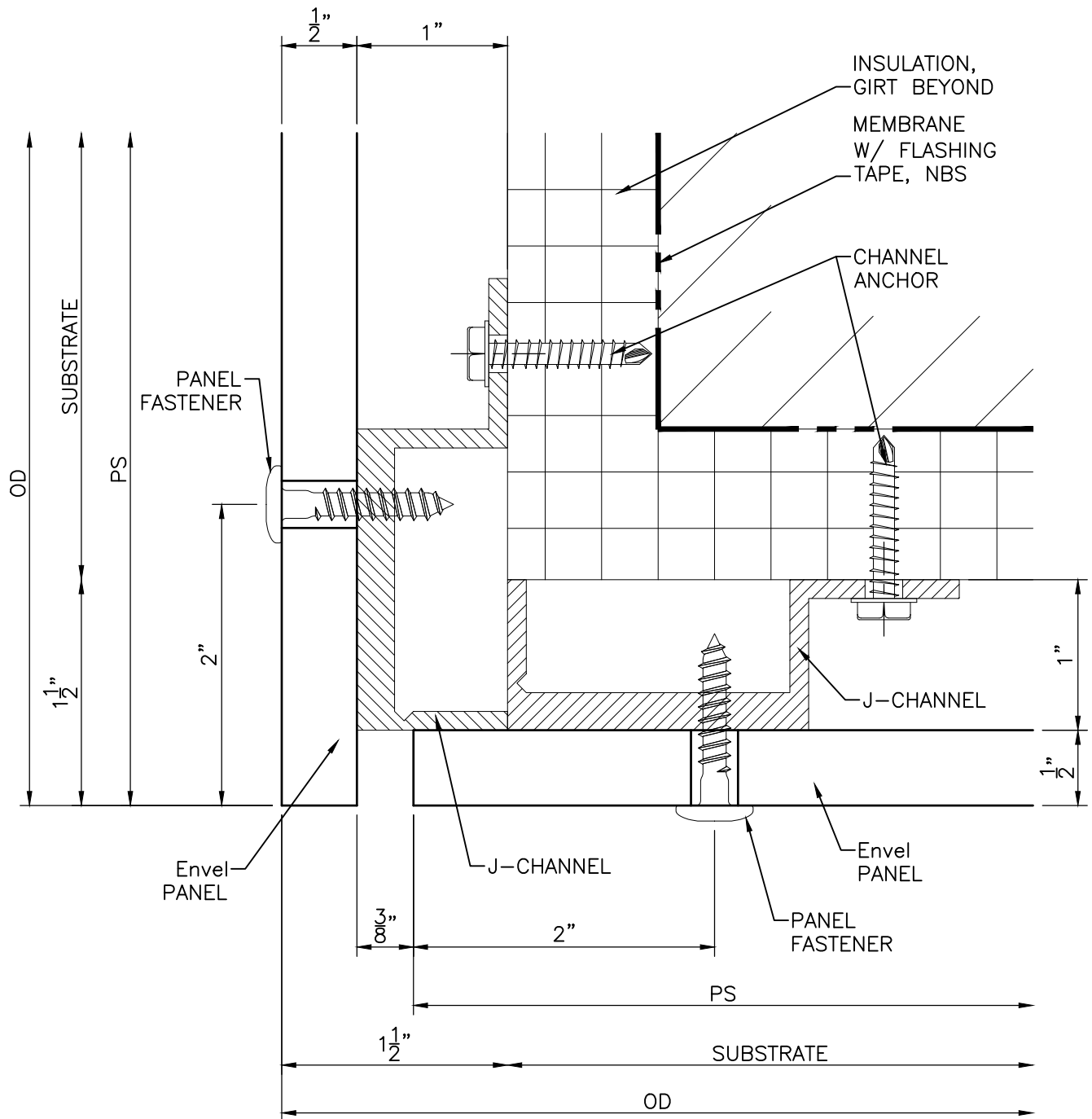

OUTSIDE CORNER (PLAN VIEW)



TITLE:

Envel PANEL SYSTEM

DRAWN BY:
SS/KAM

DATE:
4/8/16

REV.

SCALE:
FULL

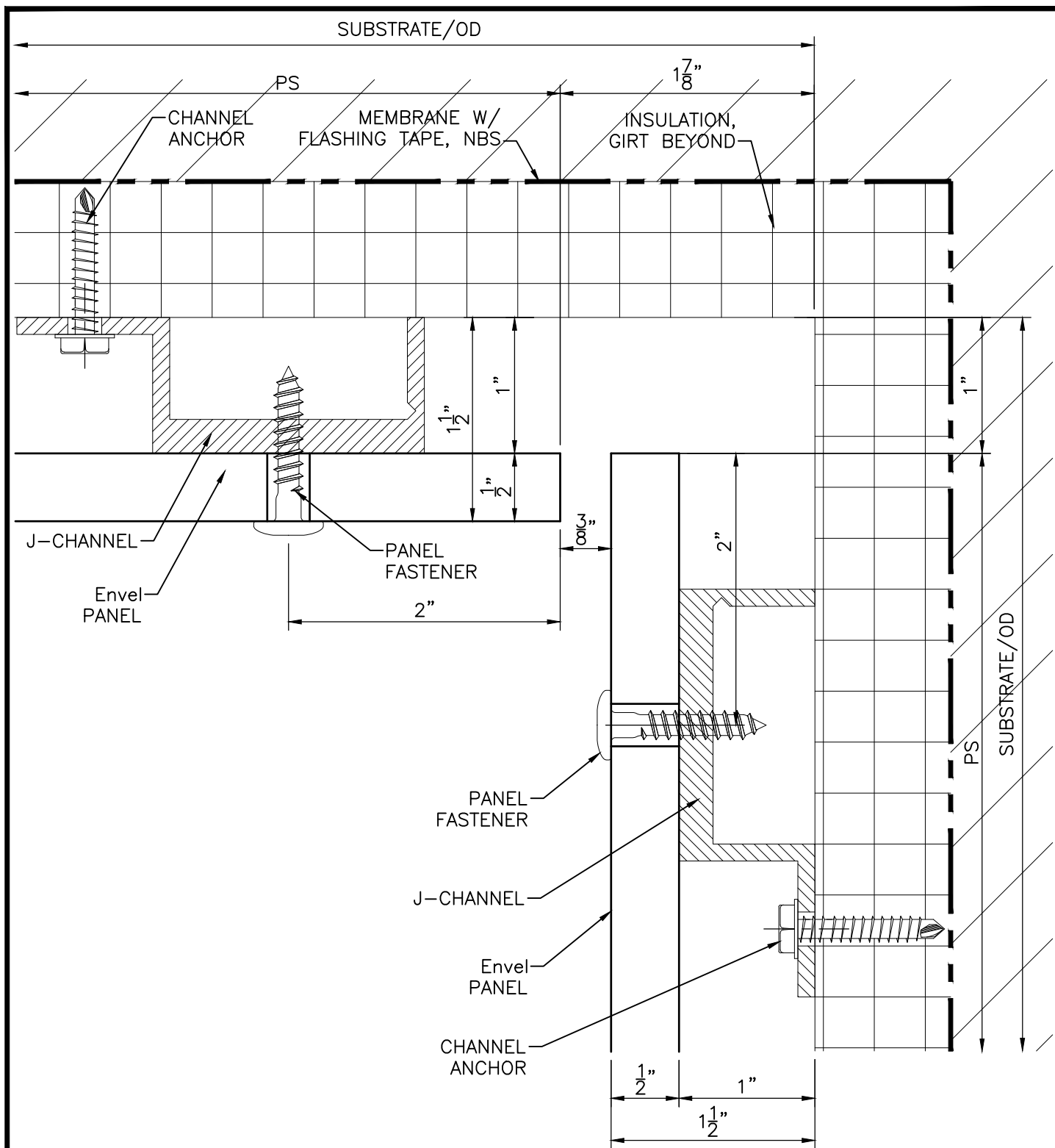

12

INSIDE CORNER (PLAN VIEW)



TITLE:

Envel PANEL SYSTEM

DRAWN BY:
SS/KAM

DATE:
4/8/16

REV.

SCALE:
FULL